



# CE EMC Test Report

Issued date: Mar. 12, 2024

Project No.: 24Q013104

**Product :** MediaTek Genio 1200 Carrier Board

**Model :** ESOM-MT-1200-CB

**Series Model :** ESOM-MT-1200 Series, ESOM-MT-1200XXXXXXXXXXXXXXXX ("X" can be 0-9, A-Z, - or blank for marketing and customized purpose)

**Applicant :** Vecow Co., Ltd

**Address :** 3F, No. 10, Jiankang Rd., Zhonghe Dist., New Taipei City 23586, Taiwan

## Report No: WD-EE-R-240065-A0

### According to

- |   |  |
|---|--|
| EN 55032: 2015 + A11: 2020, Class A         | IEC 61000-4-2: 2008 ED. 2.0              |
| BS EN 55032: 2015 + A11: 2020               | IEC 61000-4-3: 2020 ED. 4.0              |
| CISPR 32: 2015                              | IEC 61000-4-4: 2012 ED. 3.0              |
| AS/NZS CISPR 32: 2015                       | IEC 61000-4-5: 2014 + A1: 2017 ED. 3.1   |
| EN 61000-3-2: 2014                          | IEC 61000-4-6: 2013 + COR1: 2015 ED. 4.0 |
| EN IEC 61000-3-2: 2019 + A1: 2021           | IEC 61000-4-8: 2009 ED. 2.0              |
| EN 61000-3-3: 2013 + A1: 2019 + A2: 2021    | IEC 61000-4-11: 2020 ED. 3.0             |
| BS EN 61000-3-2: 2014                       | EN 61000-4-2: 2009                       |
| BS EN IEC 61000-3-2: 2019 + A1: 2021        | EN IEC 61000-4-3: 2020                   |
| BS EN 61000-3-3: 2013 + A1: 2019 + A2: 2021 | EN 61000-4-4: 2012                       |
| EN 55035: 2017 + A11: 2020                  | EN 61000-4-5: 2014 + A1: 2017            |
| BS EN 55035: 2017 + A11: 2020               | EN 61000-4-6: 2014 + AC: 2015            |
|   | EN 61000-4-8: 2010                       |
|   | EN IEC 61000-4-11: 2020 + AC: 2020       |

Authorized Signatory :  / Ken Huang



Wendell Industrial Co., Ltd  
Wendell EMC & RF Laboratory

Add: 5F-1, No. 188, Baoqiao Road, Xindian District, New Taipei City 23145, Taiwan R.O.C.



## Table of Contents

- 1 Certification ..... 7**
- 1.1 Summary of Test Result..... 8**
- 2 Test Configuration of Equipment Under Test ..... 9**
- 2.1 Test Facility..... 9**
- 2.2 Measurement Uncertainty ..... 10**
  - 2.2.1 Conducted Emission test..... 10
  - 2.2.2 Conducted emission at telecom port test ..... 10
  - 2.2.3 Radiated Emission test..... 10
- 3 General Information..... 11**
- 3.1 Description of EUT..... 11**
- 3.2 Description of Test Modes..... 12**
- 3.3 EUT Operating Condition ..... 12**
- 3.4 Description of Support Unit ..... 13**
- 3.5 Configuration of System Under Test..... 14**
- 4 Emission Test..... 15**
- 4.1 Conducted Emission Measurement ..... 15**
  - 4.1.1 Limit of Conducted Emission Measurement ..... 15
  - 4.1.2 Test Instrument ..... 16
  - 4.1.3 Test Procedure..... 17
  - 4.1.4 Deviation from Test Standard ..... 17
  - 4.1.5 Test Setup..... 18
  - 4.1.6 Test Result ..... 19
  - 4.1.7 Photographs of Test Configuration ..... 23
- 4.2 Conducted Emission at Telecommunication Ports Test ..... 24**
  - 4.2.1 Limit of Conducted Emission at Telecommunication Ports Test..... 24
  - 4.2.2 Test Instrument ..... 25
  - 4.2.3 Test Procedure..... 26
  - 4.2.4 Deviation from Test Standard ..... 26
  - 4.2.5 Test Setup..... 27
  - 4.2.6 Test Result ..... 28
  - 4.2.7 Photographs of Test Configuration ..... 31
- 4.3 Radiated Emission Measurement ..... 32**
  - 4.3.1 Limits of Radiated Emission Measurement..... 32
  - 4.3.2 Test Instrument ..... 34
  - 4.3.3 Test Procedure..... 35
  - 4.3.4 Deviation from Test Standard ..... 35
  - 4.3.5 Test Setup..... 36
  - 4.3.6 Test Result ..... 39
  - 4.3.7 Photographs of Test Configuration ..... 43
- 4.4 Harmonics Current Measurement..... 45**
  - 4.4.1 Limits of Harmonics Current Measurement ..... 45
  - 4.4.2 Test Instrument ..... 45
  - 4.4.3 Test Procedure..... 46
  - 4.4.4 Deviation from Test Standard ..... 47
  - 4.4.5 Test Setup..... 47
  - 4.4.6 Test Result ..... 48



- 4.4.7 Photographs of Test Configuration ..... 49
- 4.5 Voltage Fluctuation and Flicker Measurement ..... 50**
  - 4.5.1 Limit for Voltage Function and Flicker Measurement..... 50
  - 4.5.2 Test Instrument ..... 50
  - 4.5.3 Test Procedure..... 50
  - 4.5.4 Deviation from Test Standard ..... 50
  - 4.5.5 Test Setup..... 51
  - 4.5.6 Test Result ..... 52
  - 4.5.7 Photographs of Test Configuration ..... 53
- 5 Immunity Test ..... 54**
  - 5.1 Standard Description ..... 54**
  - 5.2 Performance Criteria ..... 55**
  - 5.3 Electrostatic Discharge (ESD) ..... 56**
    - 5.3.1 Test Specification..... 56
    - 5.3.2 Test Instrument ..... 56
    - 5.3.3 Test Procedure..... 57
    - 5.3.4 Deviation from Test Standard ..... 58
    - 5.3.5 Test Setup..... 58
    - 5.3.6 Test Result ..... 60
    - 5.3.7 Photographs of Test Configuration ..... 65
  - 5.4 Radiated, Radio-frequency, Electromagnetic Field Immunity Test (RS)..... 66**
    - 5.4.1 Test Specification..... 66
    - 5.4.2 Test Instrument ..... 67
    - 5.4.3 Test Procedure..... 68
    - 5.4.4 Deviation from Test Standard ..... 68
    - 5.4.5 Test Setup..... 69
    - 5.4.6 Test Result ..... 70
    - 5.4.7 Photographs of Test Configuration ..... 71
  - 5.5 Electrical Fast Transient /Burst Immunity Test (EFT) ..... 72**
    - 5.5.1 Test Specification..... 72
    - 5.5.2 Test Instrument ..... 72
    - 5.5.3 Test Procedure..... 73
    - 5.5.4 Deviation from Test Standard ..... 73
    - 5.5.5 Test Setup..... 74
    - 5.5.6 Test Result ..... 75
    - 5.5.7 Photographs of Test Configuration ..... 76
  - 5.6 Surge Immunity Test ..... 77**
    - 5.6.1 Test Specification..... 77
    - 5.6.2 Test Instrument ..... 78
    - 5.6.3 Test Procedure..... 78
    - 5.6.4 Deviation from Test Standard ..... 79
    - 5.6.5 Test Setup..... 79
    - 5.6.6 Test Result ..... 80
    - 5.6.7 Photographs of Test Configuration ..... 81
  - 5.7 Continuous Conducted Disturbances (CS) ..... 82**
    - 5.7.1 Test Specification..... 82
    - 5.7.2 Test Instrument ..... 82
    - 5.7.3 Test Procedure..... 83
    - 5.7.4 Deviation from Test Standard ..... 84



5.7.5	Test Setup.....	84
5.7.6	Test Result .....	85
5.7.7	Photographs of Test Configuration .....	86
<b>5.8</b>	<b>Power Frequency Magnetic Field Immunity Test .....</b>	<b>87</b>
5.8.1	Test Specification.....	87
5.8.2	Test Instrument .....	87
5.8.3	Test Procedure.....	87
5.8.4	Deviation from Test Standard .....	87
5.8.5	Test Setup.....	88
5.8.6	Test Result .....	89
5.8.7	Photographs of Test Configuration .....	90
<b>5.9</b>	<b>Voltage Dips &amp; Short Interruptions .....</b>	<b>91</b>
5.9.1	Test Specification.....	91
5.9.2	Test Instrument .....	91
5.9.3	Test Procedure.....	92
5.9.4	Deviation from Test Standard .....	92
5.9.5	Test Setup.....	93
5.9.6	Test Result .....	94
5.9.7	Photographs of Test Configuration .....	95



### History of this test report

Report No.	Issue date	Description
WD-EE-R-240065-A0	Mar. 12, 2024	Initial Issue

**Declaration**

This report is for your exclusive use. Any copying or replication of this report to or for any other person or entity, or use of our name or trademark, is permitted only with our prior written permission. This report sets forth our findings solely with respect to the test samples identified herein. The results set forth in this report are not indicative or representative of the quality or characteristics of the lot from which a test sample was taken or any similar or identical product unless specifically and expressly noted. Our report includes all of the tests requested by you and the results thereof based upon the information that you provided to us.



### History of supplementary report

Report No.	Issue date	Description
WD-EE-R-240065-A0	Mar. 12, 2024	Original report

**Declaration**

This report is for your exclusive use. Any copying or replication of this report to or for any other person or entity, or use of our name or trademark, is permitted only with our prior written permission. This report sets forth our findings solely with respect to the test samples identified herein. The results set forth in this report are not indicative or representative of the quality or characteristics of the lot from which a test sample was taken or any similar or identical product unless specifically and expressly noted. Our report includes all of the tests requested by you and the results thereof based upon the information that you provided to us.

# 1 Certification

**Product:** MediaTek Genio 1200 Carrier Board

**Model:** ESOM-MT-1200-CB

**Series Model:** ESOM-MT-1200 Series, ESOM-MT-1200XXXXXXXXXXXXX (“X” can be 0-9, A-Z, - or blank for marketing and customized purpose)

**Applicant:** Vecow Co., Ltd

**Tested:** Feb. 26 ~ Mar. 04, 2024

**Standard:** **EN 55032: 2015 + A11: 2020, Class A**  
**BS EN 55032: 2015 + A11: 2020**  
**CISPR 32: 2015**  
**AS/NZS CISPR 32: 2015**  
**EN 61000-3-2: 2014**  
**EN IEC 61000-3-2: 2019 + A1: 2021**  
**EN 61000-3-3: 2013 + A1: 2019 + A2: 2021**  
**BS EN 61000-3-2: 2014**  
**BS EN IEC 61000-3-2: 2019 + A1: 2021**  
**BS EN 61000-3-3: 2013 + A1: 2019 + A2: 2021**  
**EN 55035: 2017 + A11: 2020**  
**BS EN 55035: 2017 + A11: 2020**  
IEC 61000-4-2: 2008 ED. 2.0  
IEC 61000-4-3: 2020 ED. 4.0  
IEC 61000-4-4: 2012 ED. 3.0  
IEC 61000-4-5: 2014 + A1: 2017 ED. 3.1  
IEC 61000-4-6: 2013 + COR1: 2015 ED. 4.0  
IEC 61000-4-8: 2009 ED. 2.0  
IEC 61000-4-11: 2020 ED. 3.0  
EN 61000-4-2: 2009  
EN IEC 61000-4-3: 2020  
EN 61000-4-4: 2012  
EN 61000-4-5: 2014 + A1: 2017  
EN 61000-4-6: 2014 + AC: 2015  
EN 61000-4-8: 2010  
EN IEC 61000-4-11: 2020 + AC: 2020

The above equipment (Model: ESOM-MT-1200-CB) has been tested by **Wendell EMC & RF Laboratory**, and found compliance with the requirement of the above standards. The test record, data evaluation and Equipment Under Test (EUT) configurations represented herein are true and accurate accounts of the measurements of the sample’s EMC characteristics under the conditions specified in this report.

Please note that the measurement uncertainty are provided for informational purpose only and are not used in determining the Pass/Fail results.

## 1.1 Summary of Test Result

The EUT has been tested according to the following specifications:

Emission				
Standard	Test Item	Limit	Result	Remark
EN 55032	Conducted disturbance at mains terminals	Class A	Pass	Meets the requirements
CISPR 32	Conducted disturbance at telecommunication ports test	Class A	Pass	Meets the requirements
	Radiated disturbance	Class A	Pass	Meets the requirements
EN 61000-3-2	Harmonic current emissions	Class A	Pass	The power consumption of EUT is less than 75W and no limits apply
EN 61000-3-3	Voltage fluctuations and flicker	-	Pass	Meets the requirements

Immunity			
Standard	Test Item	Result	Remark
IEC 61000-4-2	Electrostatic discharges (ESD)	Pass	Meets the requirements of Performance Criterion A
IEC 61000-4-3	Continuous radiated disturbances (RS)	Pass	Meets the requirements of Performance Criterion A
IEC 61000-4-4	Electrical fast transients (EFT)	Pass	Meets the requirements of Performance Criterion A
IEC 61000-4-5	Surges	Pass	Meets the requirements of Performance Criterion A
IEC 61000-4-6	Continuous conducted disturbances (CS)	Pass	Meets the requirements of Performance Criterion A
IEC 61000-4-8	Power-frequency magnetic fields (PFMF)	Pass	Meets the requirements of Performance Criterion A
IEC 61000-4-11	Voltage dips and interruptions	Pass	Meets the requirements of Voltage Dips: ✧ >95% reduction – Performance Criterion A ✧ 30% reduction - Performance Criterion C Voltage Interruptions: ✧ >95% reduction – Performance Criterion C

**Note:** Test record contained in the referenced test report relate only to the EUT sample and test item.



## **2 Test Configuration of Equipment Under Test**

### **2.1 Test Facility**

**Conducted disturbance at mains terminals, Conducted disturbance at telecommunication ports, Harmonics, Flicker, ESD, EFT, Surge, CS, PFMF and DIP Tests**

W01: 5F-1, No.188, Baoqiao Rd., Xindian Dist., New Taipei City 23145, Taiwan (R.O.C)

#### **RS Test**

W05: 1F-7, No.188, Baoqiao Rd., Xindian Dist., New Taipei City 23145, Taiwan (R.O.C)

**Conducted disturbance at mains terminals, Conducted disturbance at telecommunication ports and Radiated emission (9\*6\*6 Chamber) Tests**

W08: No.119, Wugong 3rd Rd., Wugu Dist., New Taipei City 248, Taiwan (R.O.C)

#### **ACCREDITATIONS**

The laboratories are accredited and approved by the TAF according to ISO/IEC 17025.

## 2.2 Measurement Uncertainty

The measurement instrumentation uncertainty is evaluated according to CISPR 16-4-2.

This uncertainty represents an expanded uncertainty expressed at approximately the 95% confidence level using a coverage factor of  $k=2$ .

Wendell EMC & RF Laboratory  $U_{lab}$  is less than  $U_{cispr}$ , therefore compliance or non-compliance with a disturbance limit shall be determined in the following manner.

- compliance is deemed to occur if no measured disturbance level exceeds the disturbance limit;
- non-compliance is deemed to occur if any measured disturbance level exceeds the disturbance limit.

Please note that the measurement uncertainty ( $U_{lab}$ ) is provided for informational purpose only and is not used in determining the Pass/Fail results.

### 2.2.1 Conducted Emission test

Test Site	Measurement Freq. Range	dB ( $U_{lab}$ )	Note
W01-CE	150 kHz ~ 30 MHz	2.75	N/A
W08-CE	150 kHz ~ 30 MHz	2.76	N/A

### 2.2.2 Conducted emission at telecom port test

Test Site	Measurement Freq. Range	dB ( $U_{lab}$ )	Note
W01-CE	150 kHz ~ 30 MHz	2.74	N/A
W08-CE	150 kHz ~ 30 MHz	2.92	N/A

### 2.2.3 Radiated Emission test

Test Site	Measurement Freq. Range	Ant	dB ( $U_{lab}$ )	Note
W08-966-1	30 MHz ~ 200 MHz	V	3.78	N/A
	30 MHz ~ 200 MHz	H	2.69	N/A
	200 MHz ~ 1000 MHz	V	4.91	N/A
	200 MHz ~ 1000 MHz	H	3.40	N/A
	1 GHz ~ 6 GHz	V	4.48	N/A
	1 GHz ~ 6 GHz	H	4.33	N/A

### 3 General Information

#### 3.1 Description of EUT

<b>Product</b>	MediaTek Genio 1200 Carrier Board
<b>Model</b>	ESOM-MT-1200-CB
<b>Series Model</b>	ESOM-MT-1200 Series, ESOM-MT-1200XXXXXXXXXXXXXXX (“X” can be 0-9, A-Z, - or blank for marketing and customized purpose)
<b>Applicant</b>	Vecow Co., Ltd
<b>Received Date</b>	Feb. 16, 2024
<b>EUT Power Rating</b>	12Vdc (from adapter)
<b>Model Differences</b>	The models are electrically identical, different models no. are for marketing purpose. The series model information is provided by client.
<b>Operating System</b>	Linux Yocto 3.1
<b>Data Cable Supplied</b>	N/A
<b>Accessory Device</b>	N/A
<b>I/O Port</b>	Please refer to the User’s Manual

**Note:**

1. The EUT uses the follow adapter:

<b>Adapter (support unit only)</b>	
<b>Brand</b>	LITEON
<b>Model</b>	HA-1600-12
<b>Input Power</b>	100-240Vac, 1.7A, 50-60Hz
<b>Output Power</b>	12Vdc, 5.0A, 60.0W
<b>Power line</b>	Input: 1.8m non-shielded cable Output: 1m non-shielded cable with 1 core

2. The EUT’s highest operating frequency is 2.2GHz. Therefore the radiated emission is tested up to 6GHz.

### 3.2 Description of Test Modes

Test results are presented in the report as below.

Test Mode	Test Condition
<b>Conducted emission test</b>	
-	Adapter mode
<b>Conducted emission test at telecom port test</b>	
-	Adapter mode, LAN (10Mbps/100Mbps/1Gbps)
<b>Radiated emission 30MHz ~ 1GHz test</b>	
-	Adapter mode
<b>Radiated emission above 1GHz test</b>	
-	Adapter mode
<b>Harmonics, Flicker and Immunity test</b>	
-	Adapter mode

### 3.3 EUT Operating Condition

- Inserted the EUT into the enclosure and placed on test table.
- Prepare PC & NB to act as a communication partner and placed it outside of testing area.
- The EUT was connected to the PC & NB with LAN cable.
- The communication partner sent data to EUT by command "ping" via LAN.
- The EUT run test program "BurnIN.exe" to enable all functions.
- The EUT sent "Color Bar ITU-R.BT471-1" signal to monitor and displayed on screen.
- The EUT sent voice signal to earphone.



### 3.4 Description of Support Unit

The EUT has been conducted testing with other necessary accessories or support units.

Item	Equipment	Brand	Model No.	Serial No.	FCC ID	Data Cable	Power Cable	Remark
1	Desktop PC	DELL	D13M	H6K10 A00	FCC DoC Approved	20m CAT.5E non-shielded RJ45 cable	1.8m non-shielded cable	-
2	Notebook	acer	ZQ0	NXV9V TA01344718C4 B7600	FCC DoC Approved	20m CAT.5E non-shielded RJ45 cable	AC: 1m non-shielded cable DC: 1.4m non-shielded cable with 1 core	-
3	1080P Monitor	DELL	P2317H	CN-0PGX4T-Q DC00-7C6-OLE B-A05	FCC DoC Approved	1.5m shielded HDMI cable with 2 cores	1.8m non-shielded cable	-
4	Keyboard	Logitech	Y-U0009	1710SC500LA8	FCC DoC Approved	1.5m non-shielded cable	N/A	-
5	Mouse	Logitech	M-U0026	HS726HB	FCC DoC Approved	2m non-shielded cable	N/A	-
6	Earphone & Microphone	E-books	E-EPA057	N/A	N/A	1.4m non-shielded cable	N/A	-
7	MediaTek Genio 1200 System on Module	Vecow	ESOM-MT-1200	N/A	N/A	N/A	N/A	Supplied by client
8	Enclosure	N/A	N/A	N/A	N/A	N/A	N/A	Supplied by client
9	RS232 terminator	N/A	N/A	N/A	N/A	N/A	N/A	Supplied by client

- Note:**
1. The core(s) is(are) originally attached to the cable(s).
  2. Item 1-2 acted as communication partners to transfer data.

### 3.5 Configuration of System Under Test

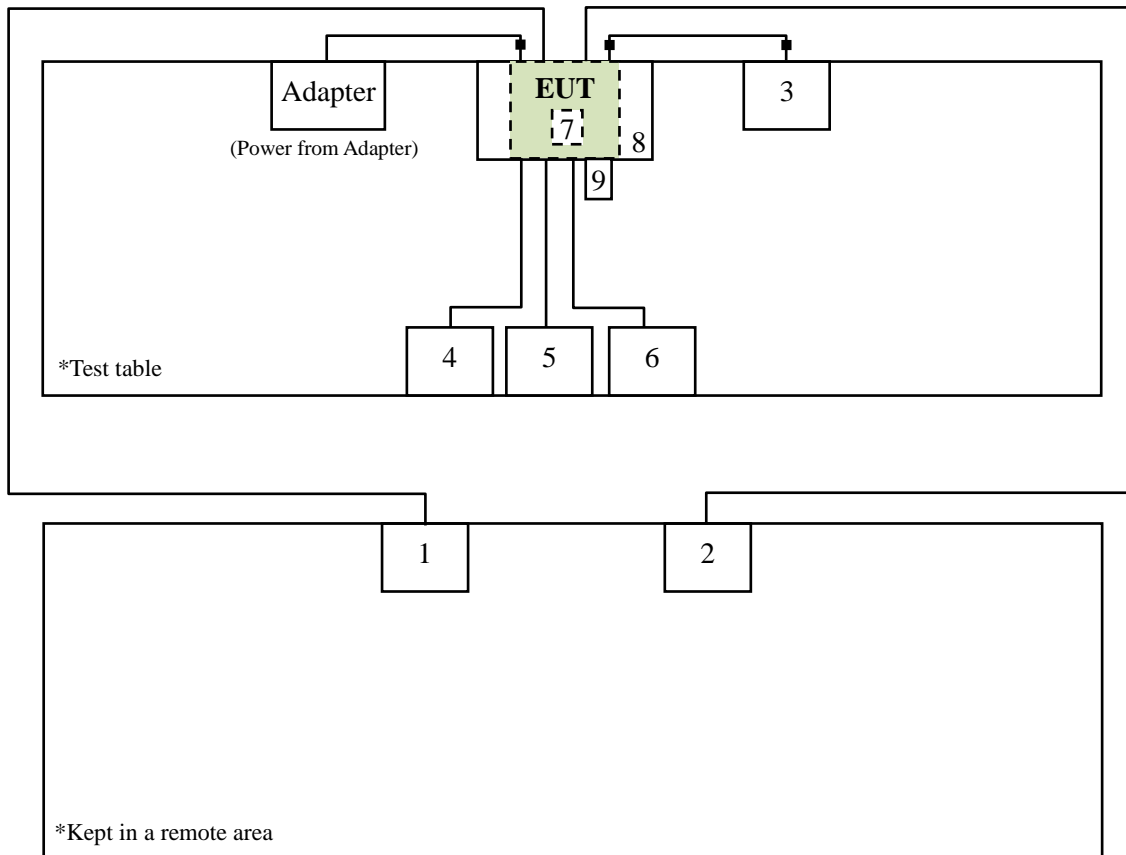

## 4 Emission Test

### 4.1 Conducted Emission Measurement

#### 4.1.1 Limit of Conducted Emission Measurement

Class A equipment:

Requirements for conducted emissions from the AC mains power ports of Class A equipment			
Frequency (MHz)	Measurement		Class A limits dB( $\mu$ V)
	Coupling device	Detector type/ bandwidth	
0.15 to 0.5	AMN	Quasi Peak / 9 kHz	79
0.5 to 30			73
0.15 to 0.5	AMN	Average / 9 kHz	66
0.5 to 30			60

Class B equipment:

Requirements for conducted emissions from the AC mains power ports of Class B equipment			
Frequency (MHz)	Measurement		Class B limits dB( $\mu$ V)
	Coupling device	Detector type/ bandwidth	
0.15 to 0.5	AMN	Quasi Peak / 9 kHz	66 to 56*
0.5 to 5			56
5 to 30			60
0.15 to 0.5	AMN	Average / 9 kHz	56 to 46*
0.5 to 5			46
5 to 30			50

\* Decreases with the logarithm of the frequency.

- Note:**
- The lower limit shall apply at the transition frequencies.
  - Detector function in the form: PK = Peak, QP = Quasi Peak, AV = Average
  - The test result calculated as following:  
 Measurement Value = Reading Level + Correct Factor  
 Correction Factor = Insertion loss of LISN + Cable loss + Transient Limiter (If use)  
 Margin Level = Measurement Value – Limit Value



#### 4.1.2 Test Instrument

Test Site: W01-CE					
Item	Equipment	Manufacturer	Model	Meter No.	Calibration Date
1	TWO-LINE V-NETWORK	R&S	ENV216	CT-1-025-1	Jun. 09, 2023
2	Pulse limiter	R&S	ESH3-Z2	CT-2-015	Jun. 01, 2023
3	EMI Test Receiver	R&S	ESCI	CT-1-024	May 30, 2023
4	Artificial Mains Network (AMN)	SCHWARZBECK	NSLK 8127	CT-1-104-1	Jun. 09, 2023
5	RF Cable	MVE	200200.400LL .500A	CT-9-101	Jun. 01, 2023
6	50ohm Termination	N/A	N/A	CT-1-065-1	Jun. 12, 2023
7	Measurement Software	EZ-EMC	Ver: EMC-CON 3A1	CT-3-012	No calibration request

**Note:** 1. The calibration interval of the above test instruments is 12 months.

Test Site: W08-CE					
Item	Equipment	Manufacturer	Model	Meter No.	Calibration Date
1	TWO-LINE V-NETWORK	R&S	ENV216	CT-1-025-2	Jun. 16, 2023
2	RF Cable	EMCI	EMCCFD300-BM-BM-5000	CT-1-107-2	Jun. 17, 2023
3	EMI Test Receiver	R&S	ESR3	CT-1-103	Jun. 19, 2023
4	Artificial Mains Network (AMN)	SCHWARZBECK	NSLK 8127 RC	CT-1-104-1R C	Jun. 16, 2023
5	Transient Limiter	Electro-Metrics	EM-7600	CT-1-026	Jun. 17, 2023
6	50ohm Termination	N/A	N/A	CT-1-109-1	Jun. 16, 2023
7	Measurement Software	EZ-EMC	Ver: EMC-CON 3A1	CT-3-012	No calibration request

**Note:** 1. The calibration interval of the above test instruments is 12 months.



### 4.1.3 Test Procedure

- a. The table-top EUT was placed 0.8 meter height wooden table from the horizontal ground plane with EUT being connected to power source through a line impedance stabilization network (LISN). The floor-standing EUT was placed insulation support unit from the horizontal ground plane. The LISN at least be 80 cm from nearest chassis of EUT.
- b. The line impedance stabilization network (LISN) provides 50 ohm/50uH of coupling impedance for the measuring instrument. All other support equipments powered from additional LISN(s).
- c. Interrelating cables that hang closer than 40 cm to the ground plane shall be folded back and forth in the center forming a bundle. All I/O cables were positioned to simulate typical usage.
- d. All I/O cables that are not connected to a peripheral shall be bundle in the center. The end of the cable may be terminated, if required, using the correct terminating impedance. The overall length shall not exceed 1 m.
- e. The EMI test receiver connected to LISN powering the EUT. The actual test configuration, please refer to EUT test photos.
- f. The receiver scanned from 150kHz to 30MHz for emissions in each of test modes. A scan was taken on both power lines, Line and Neutral, recording at least six highest emissions.
- g. The EUT and cable configuration of the above highest emission levels were recorded. The test data of the worst case was recorded.

### 4.1.4 Deviation from Test Standard

No deviation

### 4.1.5 Test Setup

#### < Table-Top equipment >

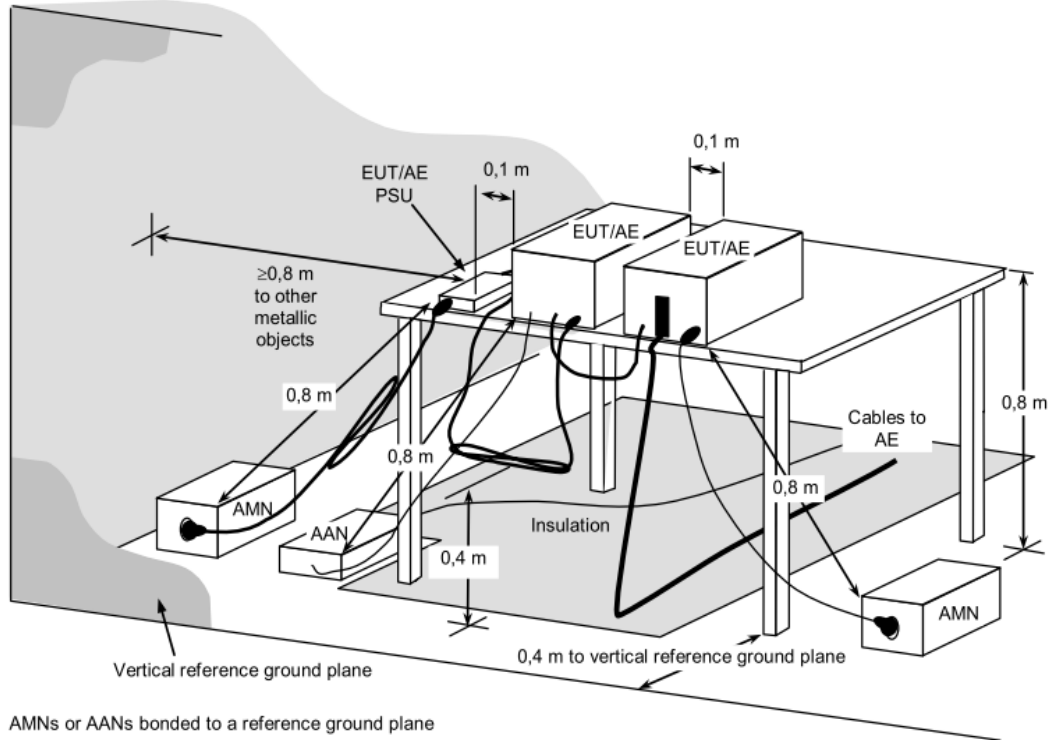

#### < Floor-Standing equipment >

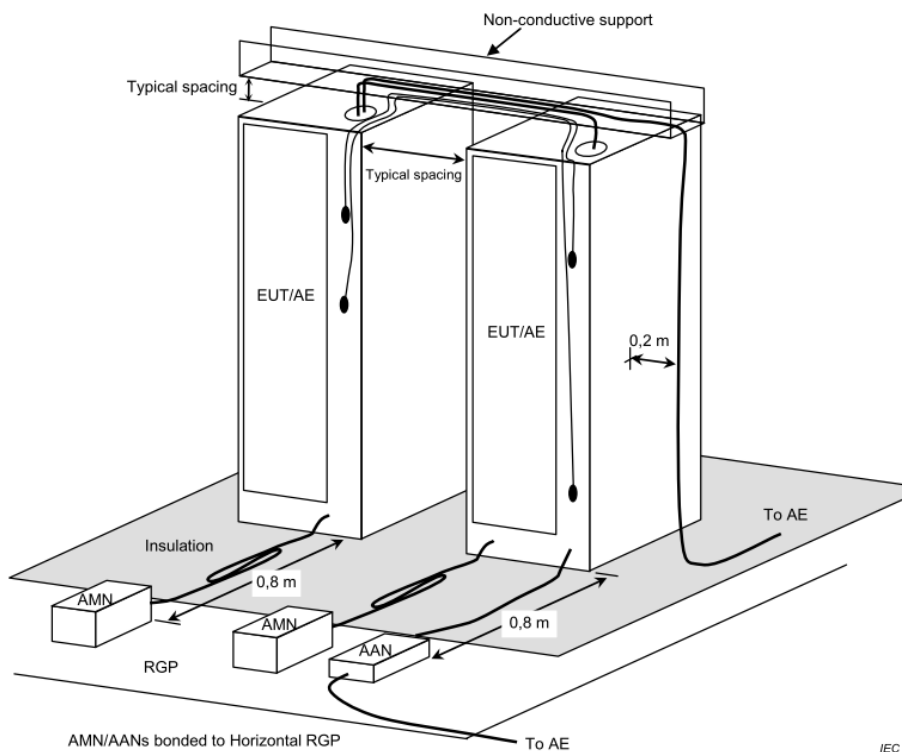

**Note:** Please refer to 4.1.7 for the actual test configuration.



### 4.1.6 Test Result

Test Voltage	230Vac, 50Hz	Frequency Range	0.15-30 MHz
Environmental Conditions	22°C, 63% RH	6dB Bandwidth	9 kHz
Test Date	2024/03/01	Phase	L
Tested by	Guanwei Liao	Test Site	W01-CE

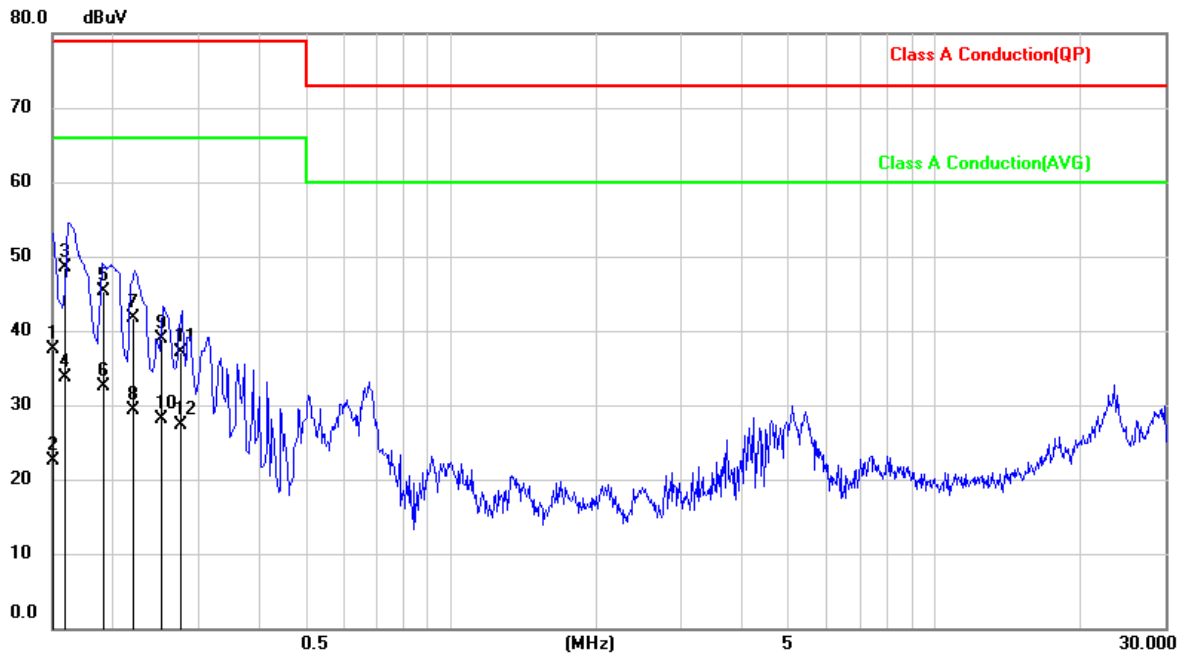

No.	Frequency (MHz)	Reading Level (dBμV)	Correct Factor (dB)	Measurement (dBμV)	Limit (dBμV)	Margin (dB)	Detector
1	0.1500	27.60	9.95	37.55	79.00	-41.45	QP
2	0.1500	12.61	9.95	22.56	66.00	-43.44	AVG
3	0.1590	38.47	9.95	48.42	79.00	-30.58	QP
4	0.1590	23.85	9.95	33.80	66.00	-32.20	AVG
5	0.1913	35.33	9.95	45.28	79.00	-33.72	QP
6	0.1913	22.48	9.95	32.43	66.00	-33.57	AVG
7	0.2206	31.81	9.95	41.76	79.00	-37.24	QP
8	0.2206	19.36	9.95	29.31	66.00	-36.69	AVG
9	0.2512	28.94	9.95	38.89	79.00	-40.11	QP
10	0.2512	18.18	9.95	28.13	66.00	-37.87	AVG
11	0.2751	27.06	9.95	37.01	79.00	-41.99	QP
12	0.2751	17.33	9.95	27.28	66.00	-38.72	AVG

- Remark:**
1. QP = Quasi Peak, AVG = Average
  2. Correction Factor = Insertion loss of LISN + Cable loss + Transient Limiter (If use)
  3. Measurement Value = Reading Level + Correct Factor
  4. Margin Level = Measurement Value - Limit Value



<b>Test Voltage</b>	230Vac, 50Hz	<b>Frequency Range</b>	0.15-30 MHz
<b>Environmental Conditions</b>	22°C, 63% RH	<b>6dB Bandwidth</b>	9 kHz
<b>Test Date</b>	2024/03/01	<b>Phase</b>	N
<b>Tested by</b>	Guanwei Liao	<b>Test Site</b>	W01-CE

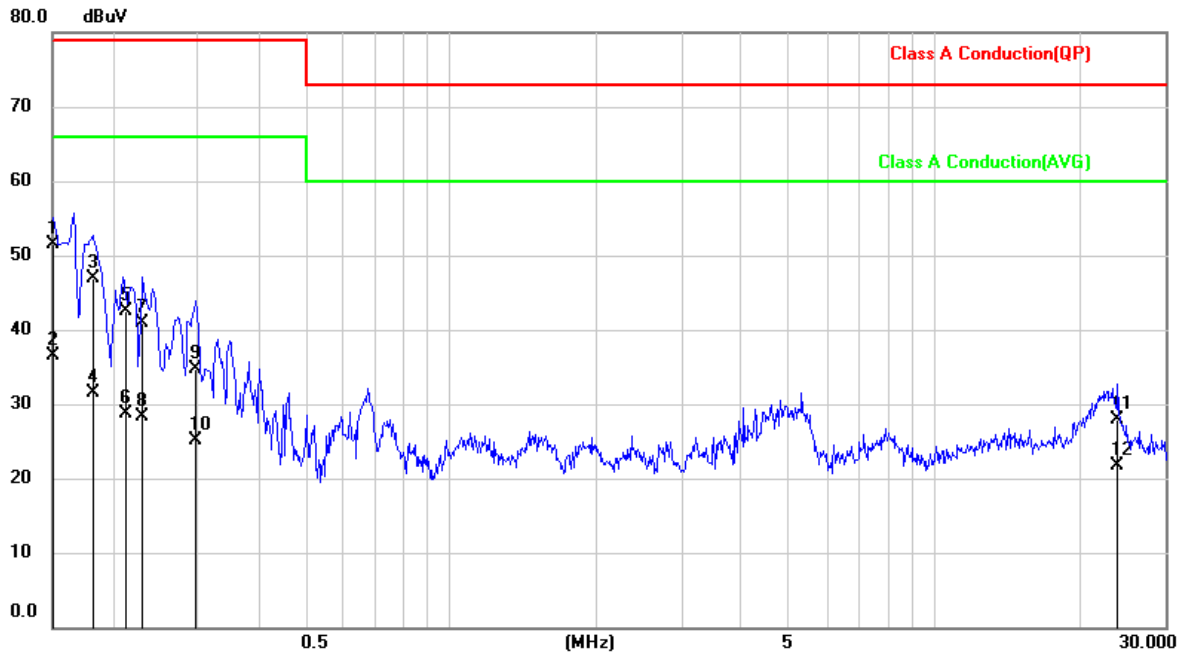

No.	Frequency (MHz)	Reading Level (dBμV)	Correct Factor (dB)	Measurement (dBμV)	Limit (dBμV)	Margin (dB)	Detector
1	0.1507	41.58	9.97	51.55	79.00	-27.45	QP
2	0.1507	26.63	9.97	36.60	66.00	-29.40	AVG
3	0.1831	36.88	9.96	46.84	79.00	-32.16	QP
4	0.1831	21.61	9.96	31.57	66.00	-34.43	AVG
5	0.2137	32.64	9.96	42.60	79.00	-36.40	QP
6	0.2137	18.83	9.96	28.79	66.00	-37.21	AVG
7	0.2312	31.02	9.96	40.98	79.00	-38.02	QP
8	0.2312	18.35	9.96	28.31	66.00	-37.69	AVG
9	0.2962	24.68	9.96	34.64	79.00	-44.36	QP
10	0.2962	15.11	9.96	25.07	66.00	-40.93	AVG
11	23.9834	17.53	10.47	28.00	73.00	-45.00	QP
12	23.9834	11.32	10.47	21.79	60.00	-38.21	AVG

**Remark:** 1. QP = Quasi Peak, AVG = Average  
 2. Correction Factor = Insertion loss of LISN + Cable loss + Transient Limiter (If use)  
 3. Measurement Value = Reading Level + Correct Factor  
 4. Margin Level = Measurement Value - Limit Value



Test Voltage	110Vac, 60Hz	Frequency Range	0.15-30 MHz
Environmental Conditions	22°C, 63% RH	6dB Bandwidth	9 kHz
Test Date	2024/03/01	Phase	L
Tested by	Guanwei Liao	Test Site	W01-CE

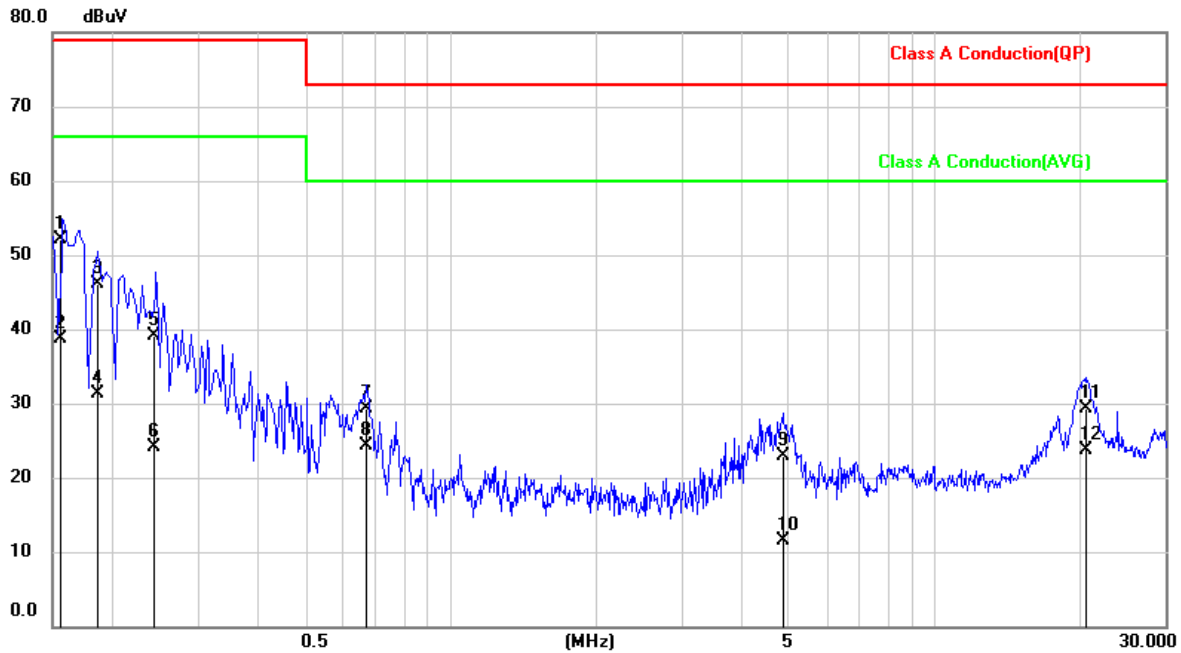

No.	Frequency (MHz)	Reading Level (dBμV)	Correct Factor (dB)	Measurement (dBμV)	Limit (dBμV)	Margin (dB)	Detector
1	0.1548	42.19	9.95	52.14	79.00	-26.86	QP
2	0.1548	28.68	9.95	38.63	66.00	-27.37	AVG
3	0.1847	36.23	9.95	46.18	79.00	-32.82	QP
4	0.1847	21.40	9.95	31.35	66.00	-34.65	AVG
5	0.2429	29.14	9.95	39.09	79.00	-39.91	QP
6	0.2429	14.06	9.95	24.01	66.00	-41.99	AVG
7	0.6726	19.43	9.95	29.38	73.00	-43.62	QP
8	0.6726	14.45	9.95	24.40	60.00	-35.60	AVG
9	4.8938	12.79	10.09	22.88	73.00	-50.12	QP
10	4.8938	1.49	10.09	11.58	60.00	-48.42	AVG
11	20.5995	19.05	10.34	29.39	73.00	-43.61	QP
12	20.5995	13.27	10.34	23.61	60.00	-36.39	AVG

**Remark:** 1. QP = Quasi Peak, AVG = Average  
2. Correction Factor = Insertion loss of LISN + Cable loss + Transient Limiter (If use)  
3. Measurement Value = Reading Level + Correct Factor  
4. Margin Level = Measurement Value - Limit Value



Test Voltage	110Vac, 60Hz	Frequency Range	0.15-30 MHz
Environmental Conditions	22°C, 63% RH	6dB Bandwidth	9 kHz
Test Date	2024/03/01	Phase	N
Tested by	Guanwei Liao	Test Site	W01-CE

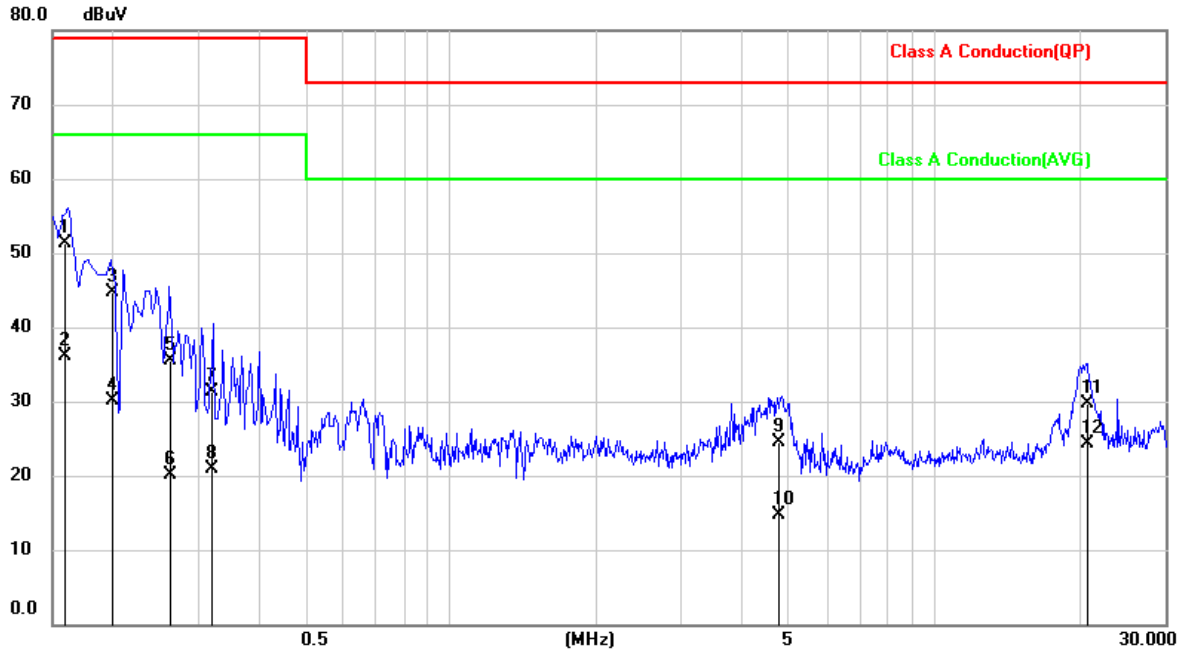

No.	Frequency (MHz)	Reading Level (dBμV)	Correct Factor (dB)	Measurement (dBμV)	Limit (dBμV)	Margin (dB)	Detector
1	0.1587	41.31	9.97	51.28	79.00	-27.72	QP
2	0.1587	26.13	9.97	36.10	66.00	-29.90	AVG
3	0.2000	34.74	9.96	44.70	79.00	-34.30	QP
4	0.2000	20.09	9.96	30.05	66.00	-35.95	AVG
5	0.2641	25.51	9.96	35.47	79.00	-43.53	QP
6	0.2641	10.16	9.96	20.12	66.00	-45.88	AVG
7	0.3193	21.39	9.97	31.36	79.00	-47.64	QP
8	0.3193	10.86	9.97	20.83	66.00	-45.17	AVG
9	4.7753	14.47	10.13	24.60	73.00	-48.40	QP
10	4.7753	4.62	10.13	14.75	60.00	-45.25	AVG
11	20.7356	19.27	10.41	29.68	73.00	-43.32	QP
12	20.7356	13.82	10.41	24.23	60.00	-35.77	AVG

**Remark:** 1. QP = Quasi Peak, AVG = Average  
 2. Correction Factor = Insertion loss of LISN + Cable loss + Transient Limiter (If use)  
 3. Measurement Value = Reading Level + Correct Factor  
 4. Margin Level = Measurement Value - Limit Value

### 4.1.7 Photographs of Test Configuration

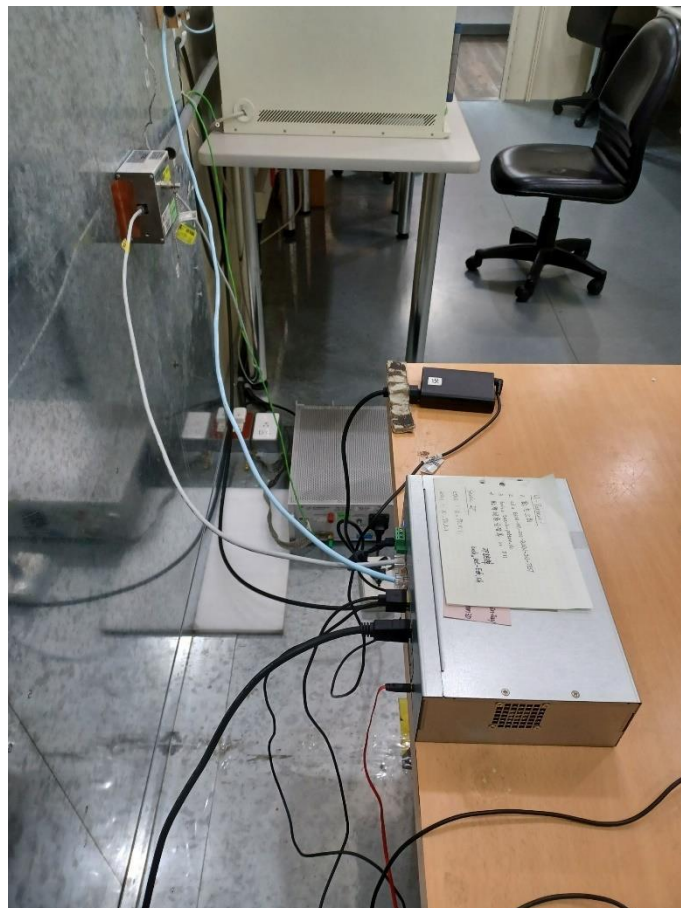
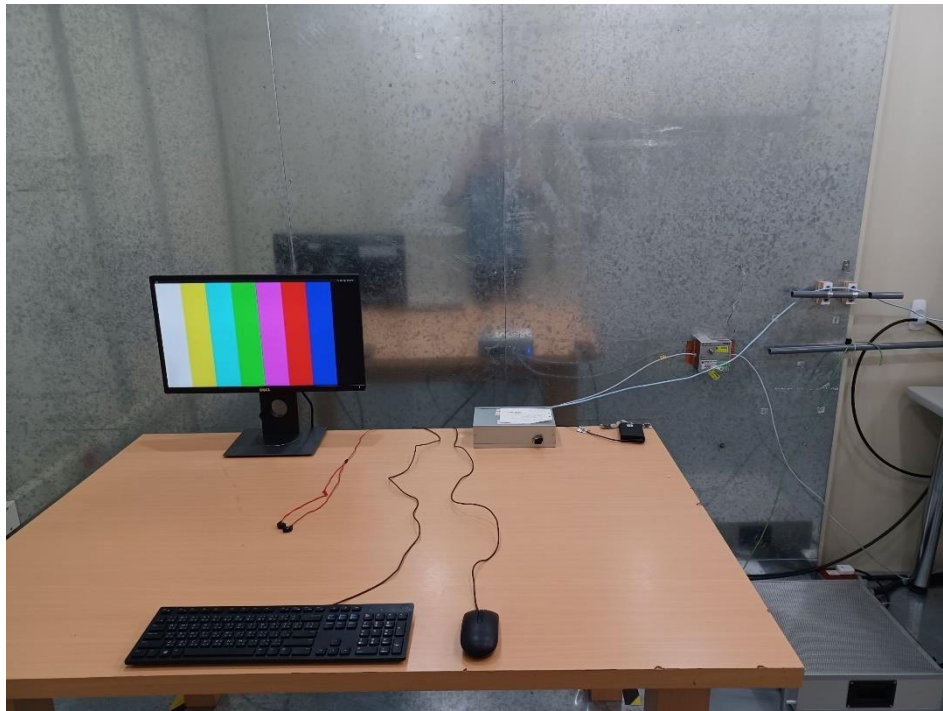

## 4.2 Conducted Emission at Telecommunication Ports Test

### 4.2.1 Limit of Conducted Emission at Telecommunication Ports Test

Class A equipment:

Requirements for asymmetric mode conducted emissions from Class A equipment			
Frequency (MHz)	Measurement		Class A limits dB(μV)
	Coupling device	Detector type/ bandwidth	
0.15 to 0.5	AAN	Quasi Peak / 9 kHz	97 to 87*
0.5 to 30			87
0.15 to 0.5	AAN	Average / 9 kHz	84 to 74*
0.5 to 30			74

\* Decreases with the logarithm of the frequency.

Class B equipment:

Requirements for asymmetric mode conducted emissions from Class B equipment			
Frequency (MHz)	Measurement		Class B limits dB(μV)
	Coupling device	Detector type/ bandwidth	
0.15 to 0.5	AAN	Quasi Peak / 9 kHz	84 to 74*
0.5 to 30			74
0.15 to 0.5	AAN	Average / 9 kHz	74 to 64*
0.5 to 30			64

\* Decreases with the logarithm of the frequency.

- Note:**
1. The lower limit shall apply at the transition frequencies.
  2. Detector function in the form: PK = Peak, QP = Quasi Peak, AV = Average
  3. The test result calculated as following:  
 Measurement Value = Reading Level + Correct Factor  
 Correction Factor = Insertion loss of ISN + Cable loss  
 Margin Level = Measurement Value – Limit Value





#### 4.2.2 Test Instrument

Test Site: W01-CE					
Item	Equipment	Manufacturer	Model	Meter No.	Calibration Date
1	TWO-LINE V-NETWORK	R&S	ENV216	CT-1-025-1	Jun. 09, 2023
2	EMI Test Receiver	R&S	ESCI	CT-1-024	May 30, 2023
3	Impedance Stabilization Network	TESEQ	T8-CAT6	CT-1-105	Jun. 02, 2023
4	Artificial Mains Network (AMN)	SCHWARZBECK	NSLK 8127	CT-1-104-1	Jun. 09, 2023
5	RF Cable	MVE	200200.400LL .500A	CT-9-101	Jun. 01, 2023
6	50ohm Termination	N/A	N/A	CT-1-065-2	Jun. 12, 2023
7	Measurement Software	EZ-EMC	Ver: EMC-CON 3A1	CT-3-012	No calibration request

**Note:** 1. The calibration interval of the above test instruments is 12 months.

Test Site: W08-CE					
Item	Equipment	Manufacturer	Model	Meter No.	Calibration Date
1	TWO-LINE V-NETWORK	R&S	ENV216	CT-1-025-2	Jun. 16, 2023
2	RF Cable	EMCI	EMCCFD300-BM-BM-5000	CT-1-107-2	Jun. 17, 2023
3	EMI Test Receiver	R&S	ESR3	CT-1-103	Jun. 19, 2023
4	Artificial Mains Network (AMN)	SCHWARZBECK	NSLK 8127 RC	CT-1-104-1R C	Jun. 16, 2023
5	Four Balanced Pair ISN	FCC	F-071115-105 7-1-09	CT-1-027	Jun. 16, 2023
6	50ohm Termination	N/A	N/A	CT-1-109-2	Jun. 16, 2023
7	Measurement Software	EZ-EMC	Ver: EMC-CON 3A1	CT-3-012	No calibration request

**Note:** 1. The calibration interval of the above test instruments is 12 months.

### 4.2.3 Test Procedure

- a. The table-top EUT was placed 0.8 meter height wooden table from the horizontal ground plane with EUT being connected to power source through a line impedance stabilization network (LISN). The floor-standing EUT was placed insulation support unit from the horizontal ground plane. The LISN at least be 80 cm from nearest chassis of EUT.
- b. The line impedance stabilization network (LISN) provides 50 ohm/50uH of coupling impedance for the measuring instrument. All other support equipments powered from additional LISN(s).
- c. Interrelating cables that hang closer than 40 cm to the ground plane shall be folded back and forth in the center forming a bundle. All I/O cables were positioned to simulate typical usage.
- d. All I/O cables that are not connected to a peripheral shall be bundle in the center. The end of the cable may be terminated, if required, using the correct terminating impedance. The overall length shall not exceed 1 m.
- e. ISN at least 80 cm from nearest chassis of EUT. The communication function of EUT was executed in normal condition. ISN was connected between EUT and associated equipment and ISN was connected directly to reference ground plane. The actual test configuration, please refer to EUT test photos.
- f. The receiver scanned from 150kHz to 30MHz for emissions in each of test modes. The test mode included 10Mbps, 100Mbps, 1Gbps, 10Gbps and POE mode. Emission frequency and amplitude were recorded, recording at least six highest emissions.
- g. The EUT and cable configuration of the above highest emission levels were recorded. The test data of the worst case was recorded.

### 4.2.4 Deviation from Test Standard

No deviation





### 4.2.6 Test Result

Test Voltage	230Vac, 50Hz	Frequency Range	0.15-30 MHz
Environmental Conditions	22°C, 63% RH	6dB Bandwidth	9 kHz
Test Date	2024/03/01	Test Condition	LAN port with ISN (10Mbps)
Tested by	Guanwei Liao	Test Site	W01-CE

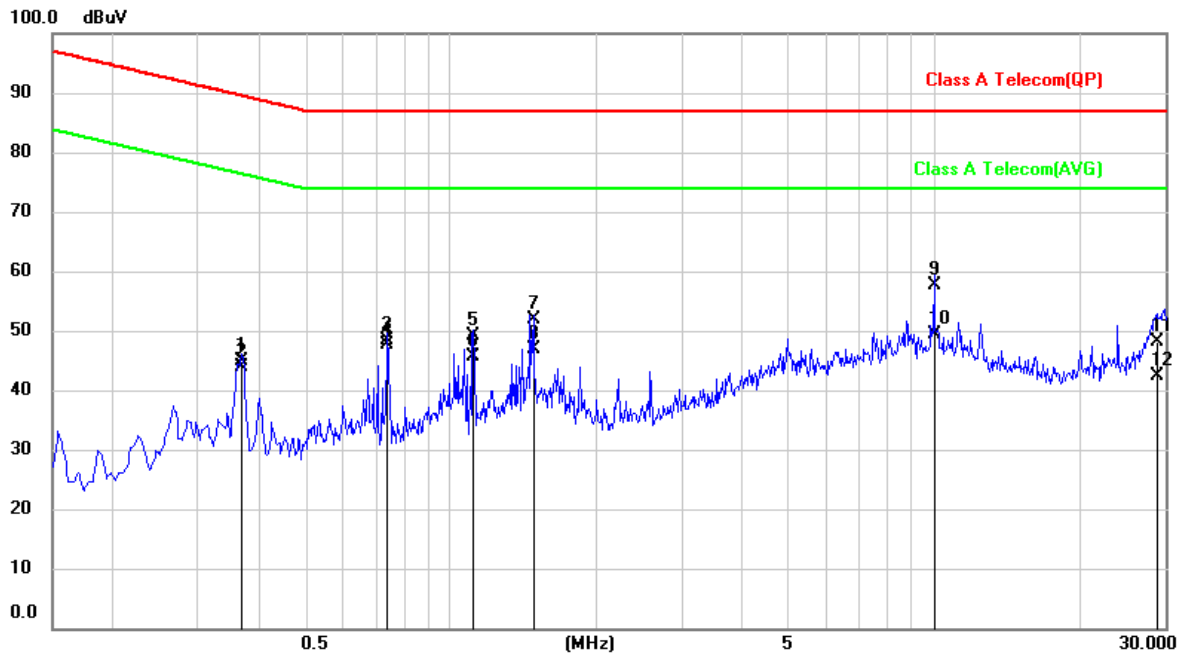

No.	Frequency (MHz)	Reading Level (dBμV)	Correct Factor (dB)	Measurement (dBμV)	Limit (dBμV)	Margin (dB)	Detector
1	0.3701	25.43	19.55	44.98	89.50	-44.52	QP
2	0.3701	24.43	19.55	43.98	76.50	-32.52	AVG
3	0.7419	29.06	19.44	48.50	87.00	-38.50	QP
4	0.7419	28.10	19.44	47.54	74.00	-26.46	AVG
5	1.1110	29.81	19.41	49.22	87.00	-37.78	QP
6	1.1110	26.26	19.41	45.67	74.00	-28.33	AVG
7	1.4831	32.39	19.40	51.79	87.00	-35.21	QP
8	1.4831	27.55	19.40	46.95	74.00	-27.05	AVG
9	10.0014	38.22	19.45	57.67	87.00	-29.33	QP
10	10.0014	29.86	19.45	49.31	74.00	-24.69	AVG
11	28.7973	28.37	19.68	48.05	87.00	-38.95	QP
12	28.7973	22.77	19.68	42.45	74.00	-31.55	AVG

**Remark:** 1. QP = Quasi Peak, AVG = Average  
 2. Correction Factor = Insertion loss of ISN + Cable loss  
 3. Measurement Value = Reading Level + Correct Factor  
 4. Margin Level = Measurement Value - Limit Value



<b>Test Voltage</b>	230Vac, 50Hz	<b>Frequency Range</b>	0.15-30 MHz
<b>Environmental Conditions</b>	22°C, 63% RH	<b>6dB Bandwidth</b>	9 kHz
<b>Test Date</b>	2024/03/01	<b>Test Condition</b>	LAN port with ISN (100Mbps)
<b>Tested by</b>	Guanwei Liao	<b>Test Site</b>	W01-CE

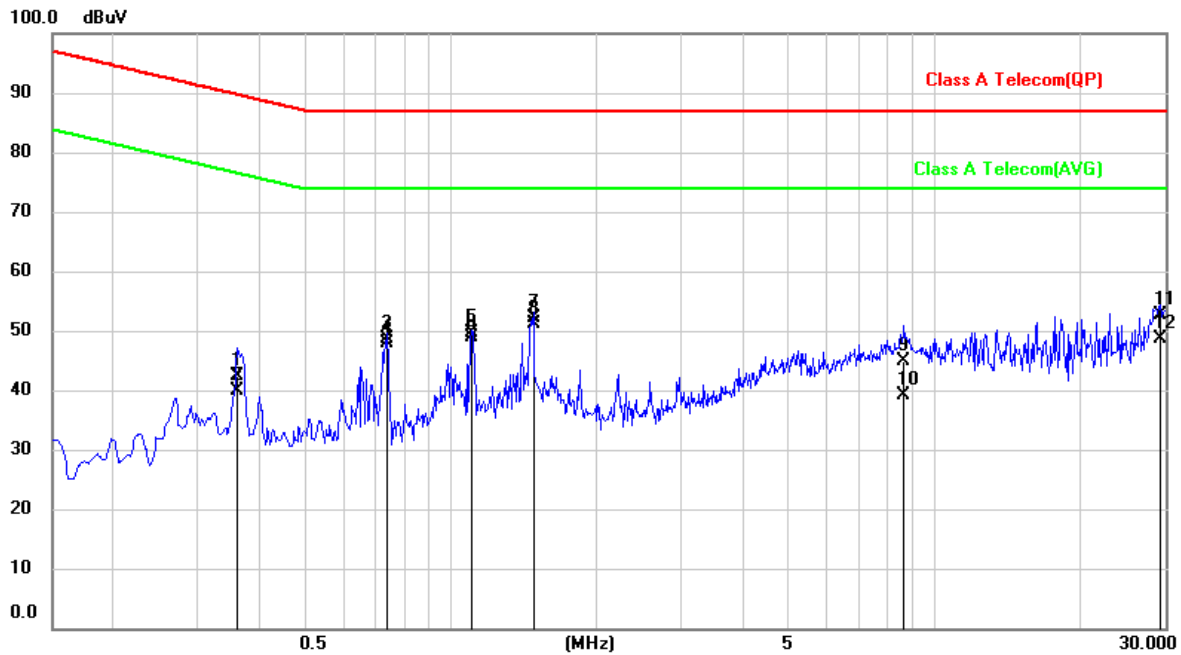

No.	Frequency (MHz)	Reading Level (dB $\mu$ V)	Correct Factor (dB)	Measurement (dB $\mu$ V)	Limit (dB $\mu$ V)	Margin (dB)	Detector
1	0.3617	22.83	19.55	42.38	89.69	-47.31	QP
2	0.3617	20.34	19.55	39.89	76.69	-36.80	AVG
3	0.7412	29.12	19.44	48.56	87.00	-38.44	QP
4	0.7412	28.42	19.44	47.86	74.00	-26.14	AVG
5	1.1125	30.16	19.41	49.57	87.00	-37.43	QP
6	1.1125	29.38	19.41	48.79	74.00	-25.21	AVG
7	1.4826	32.66	19.40	52.06	87.00	-34.94	QP
8	1.4826	31.81	19.40	51.21	74.00	-22.79	AVG
9	8.6507	25.36	19.43	44.79	87.00	-42.21	QP
10	8.6507	19.77	19.43	39.20	74.00	-34.80	AVG
11	29.2358	33.05	19.70	52.75	87.00	-34.25	QP
12	29.2358	28.84	19.70	48.54	74.00	-25.46	AVG

**Remark:** 1. QP = Quasi Peak, AVG = Average  
2. Correction Factor = Insertion loss of ISN + Cable loss  
3. Measurement Value = Reading Level + Correct Factor  
4. Margin Level = Measurement Value - Limit Value



<b>Test Voltage</b>	230Vac, 50Hz	<b>Frequency Range</b>	0.15-30 MHz
<b>Environmental Conditions</b>	22°C, 63% RH	<b>6dB Bandwidth</b>	9 kHz
<b>Test Date</b>	2024/03/01	<b>Test Condition</b>	LAN port with ISN (1Gbps)
<b>Tested by</b>	Guanwei Liao	<b>Test Site</b>	W01-CE

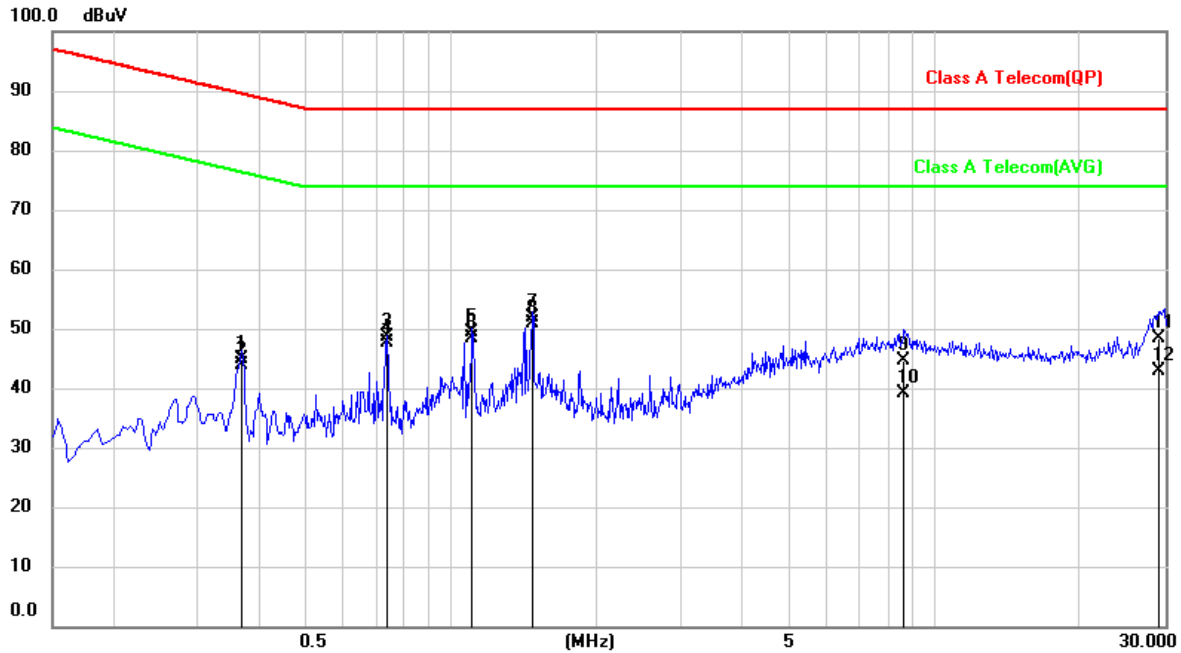

No.	Frequency (MHz)	Reading Level (dBμV)	Correct Factor (dB)	Measurement (dBμV)	Limit (dBμV)	Margin (dB)	Detector
1	0.3696	25.37	19.55	44.92	89.51	-44.59	QP
2	0.3696	24.30	19.55	43.85	76.51	-32.66	AVG
3	0.7400	29.12	19.44	48.56	87.00	-38.44	QP
4	0.7400	28.30	19.44	47.74	74.00	-26.26	AVG
5	1.1111	30.02	19.41	49.43	87.00	-37.57	QP
6	1.1111	29.02	19.41	48.43	74.00	-25.57	AVG
7	1.4804	32.52	19.40	51.92	87.00	-35.08	QP
8	1.4804	31.46	19.40	50.86	74.00	-23.14	AVG
9	8.6511	25.08	19.43	44.51	87.00	-42.49	QP
10	8.6511	19.61	19.43	39.04	74.00	-34.96	AVG
11	29.1718	28.78	19.70	48.48	87.00	-38.52	QP
12	29.1718	23.10	19.70	42.80	74.00	-31.20	AVG

**Remark:** 1. QP = Quasi Peak, AVG = Average  
 2. Correction Factor = Insertion loss of ISN + Cable loss  
 3. Measurement Value = Reading Level + Correct Factor  
 4. Margin Level = Measurement Value - Limit Value



### 4.3 Radiated Emission Measurement

#### 4.3.1 Limits of Radiated Emission Measurement

According to EN 55032 table1 - Required highest frequency for radiated measurement:

Highest internal frequency ( $F_x$ )	Highest measured frequency
$F_x \leq 108$ MHz	1 GHz
$108 \text{ MHz} < F_x \leq 500$ MHz	2 GHz
$500 \text{ MHz} < F_x \leq 1$ GHz	5 GHz
$F_x > 1$ GHz	$5 \times F_x$ up to a maximum of 6 GHz

Remark:

1.  $F_x$  : highest fundamental frequency generated or used within the EUT or highest frequency at which it operates.
2. Where  $F_x$  is unknown, the radiated emission measurements shall be performed up to 6 GHz.

Class A equipment:

Requirements for radiated emissions at frequencies up to 1 GHz for Class A equipment			
Frequency (MHz)	Measurement		Class A limits dB( $\mu$ V/m)
	Distance (m)	Detector type/ bandwidth	OATS/SAC
30 to 230	10	Quasi Peak / 120 kHz	40
230 to 1000			47
30 to 230	3		50
230 to 1000			57

Requirements for radiated emissions at frequencies above 1 GHz for Class A equipment			
Frequency (MHz)	Measurement		Class A limits dB( $\mu$ V/m)
	Distance (m)	Detector type/ bandwidth	FSOATS
1000 to 3000	3	Average / 1 MHz	56
3000 to 6000			60
1000 to 3000		Peak / 1 MHz	76
3000 to 6000			80





Class B equipment:

Requirements for radiated emissions at frequencies up to 1 GHz for Class B equipment			
Frequency (MHz)	Measurement		Class B limits dB( $\mu$ V/m)
	Distance (m)	Detector type/ bandwidth	OATS/SAC
30 to 230	10	Quasi Peak / 120 kHz	30
230 to 1000			37
30 to 230	3		40
230 to 1000			47

Requirements for radiated emissions at frequencies above 1 GHz for Class B equipment			
Frequency (MHz)	Measurement		Class B limits dB( $\mu$ V/m)
	Distance (m)	Detector type/ bandwidth	FSOATS
1000 to 3000	3	Average / 1 MHz	50
3000 to 6000			54
1000 to 3000		Peak / 1 MHz	70
3000 to 6000			74

- Note:**
- The lower limit shall apply at the transition frequency.
  - Detector function in the form: PK = Peak, QP = Quasi Peak, AV = Average
  - The test result calculated as following:  
 Measurement Value = Reading Level + Correct Factor  
 Correction Factor = Antenna factor + Cable loss (Antenna to preamplifier) - preamplifier Gain  
 + Cable loss (preamplifier to receiver)  
 Margin Level = Measurement Value - Limit Value



### 4.3.2 Test Instrument

Test Site: W08-966-1					
Item	Equipment	Manufacturer	Model	Meter No.	Calibration Date
1	Horn Antenna	Schwarzbeck	BBHA 9120D	CT-9-031	Jul. 31, 2023
2	Horn Antenna	Schwarzbeck	BBHA 9170	CT-9-032	Aug. 21, 2023
3	TRILOG Broadband Antenna with 6 dB Attenuator	Schwarzbeck & MVE	VULB 9168 & MVE2251-06	CT-1-096-1	May 17, 2023
4	Spectrum Analyzer	Agilent	E4407B	CT-1-003(1)	Aug. 02, 2023
5	EXA Signal Analyzer	Keysight	N9010A	CT-1-093	Aug. 18, 2023
6	EMI Test Receiver	Keysight	N9038A	CT-9-007	Aug. 02, 2023
7	Preamplifier	EM	EM 330	CT-9-024	Aug. 03, 2023
8	Preamplifier	SGH & MCL	SGH118 & BW-S15W2+	CT-9-071	Aug. 03, 2023
9	Preamplifier	EMCI	EMC184045SE	CT-9-013	Aug. 22, 2023
10	Test Cable	EMCI	EMCCFD400-NM-NM-1000	CT-1-132	Aug. 03, 2023
11	Test Cable	PEWC	CFD400NL-LW-NM-NM-3000	CT-1-141	Aug. 03, 2023
12	Test Cable	EMCI	EMCCFD400-NM-NM-15000	CT-1-133	Aug. 03, 2023
13	Test Cable	EMCI	EMC104-SM-35M-600	CT-1-134	Aug. 03, 2023
14	Test Cable	MVE	280280.LL266.1400	CT-9-072	Aug. 03, 2023
15	Test Cable	EMCI	EMC102-KM-KM-600	CT-1-136	Aug. 22, 2023
16	Measurement Software	EZ-EMC	Ver :WD-03A1-1	CT-3-012	No calibration request

**Note:** 1. The calibration interval of the above test instruments is 12 months.

### 4.3.3 Test Procedure

- a. The table-top EUT was placed on the top of a turntable 0.8 meters above the ground at 3 m 966 chamber. The floor-standing EUT was placed insulation support unit from the horizontal ground plane. The table was rotated 360 degrees to determine the position of the high radiation emissions.
- b. The height of the test antenna shall vary between 1 m to 4 m. Both vertical and horizontal polarizations of the antenna were set to make the measurement.
- c. The EUT was set up as per the test configuration to simulate typical usage per the user's manual. All I/O cables were positioned to simulate typical usage. The actual test configuration, please refer to EUT test photos.
- d. The initial step in collecting radiated emission data is a Spectrum Mode scanning the measurement frequency range.

#### **Below 1GHz:**

Reading in which marked as QP or Peak means measurements by using Spectrum Mode with detector RBW=120kHz.

If the Spectrum Mode measured peak value compliance with and lower than Quasi Peak Limit, the EUT shall be deemed to meet QP Limits.

#### **Above 1GHz:**

Reading in which marked as Peak & AVG means measurements by using Spectrum Mode with setting in RBW=1MHz.

If the Spectrum Mode measured value compliance with the Peak Limits and lower than AVG Limits, the EUT shall be deemed to meet both Peak and AVG Limits.

- e. Emission frequency and amplitude were recorded, recording at least six highest emissions. The EUT and cable configuration of the above highest emission levels were recorded. The test data of the worst case was recorded.

### 4.3.4 Deviation from Test Standard

No deviation

### 4.3.5 Test Setup

< Radiated Emissions Frequency: 30 MHz to 1000 MHz >

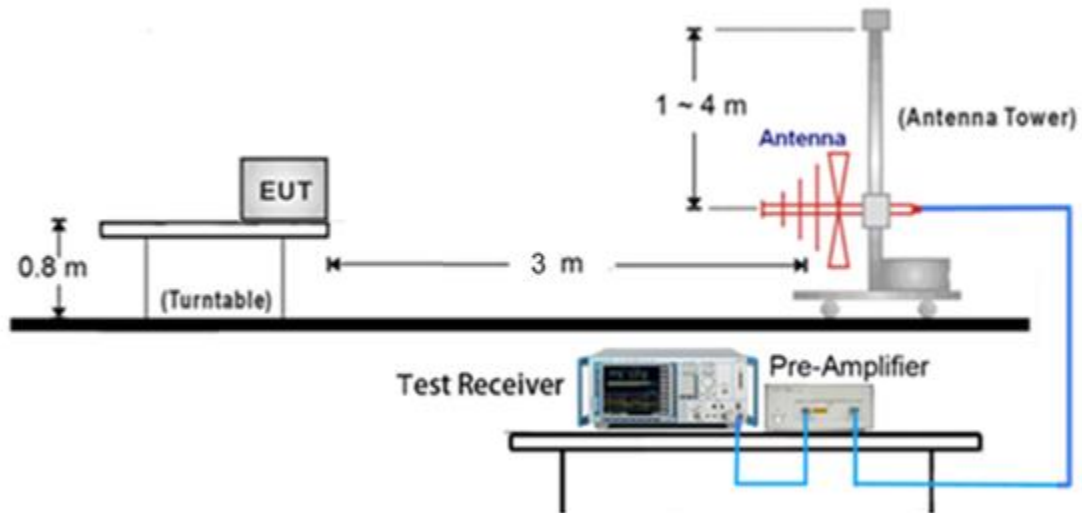

< Radiated Emissions Frequency: above 1GHz >

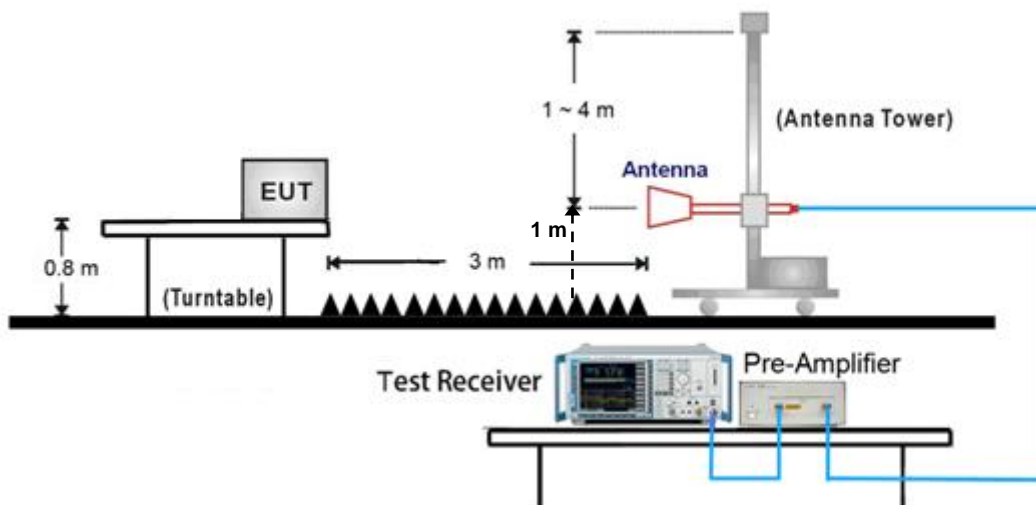

**Note:**

- (1) Please refer to the 4.3.7 for the actual test configuration.
- (2) The formula of measured value as:  $\text{Test Result} = \text{Reading} + \text{Correction Factor}$
- (3) Detector function in the form: PK = Peak, QP = Quasi Peak, AV = Average
- (4) The test result calculated as following:  
 $\text{Measurement Value} = \text{Reading Level} + \text{Correct Factor}$   
 $\text{Correct Factor} = \text{Antenna Factor} + \text{Cable Loss} - \text{Amplifier Gain (if use)}$   
 $\text{Margin Level} = \text{Measurement Value} - \text{Limit Value}$

< EUT placement top view and measurement distance >

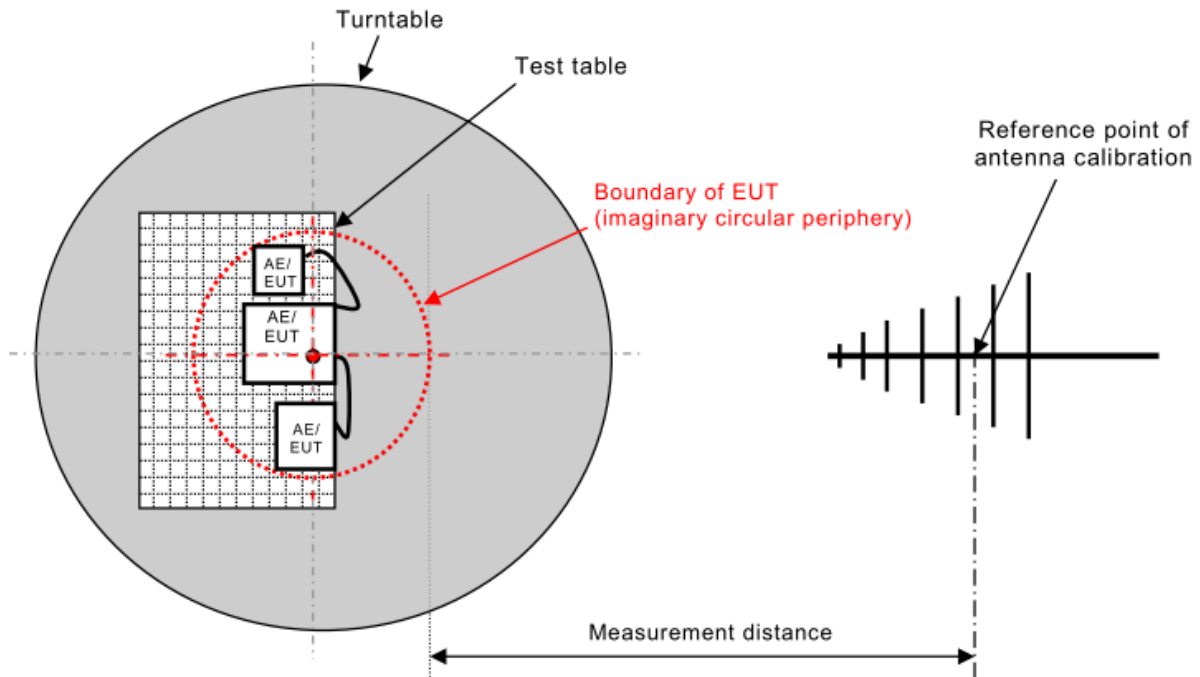

< Boundary of EUT, Local AE and associated cabling >

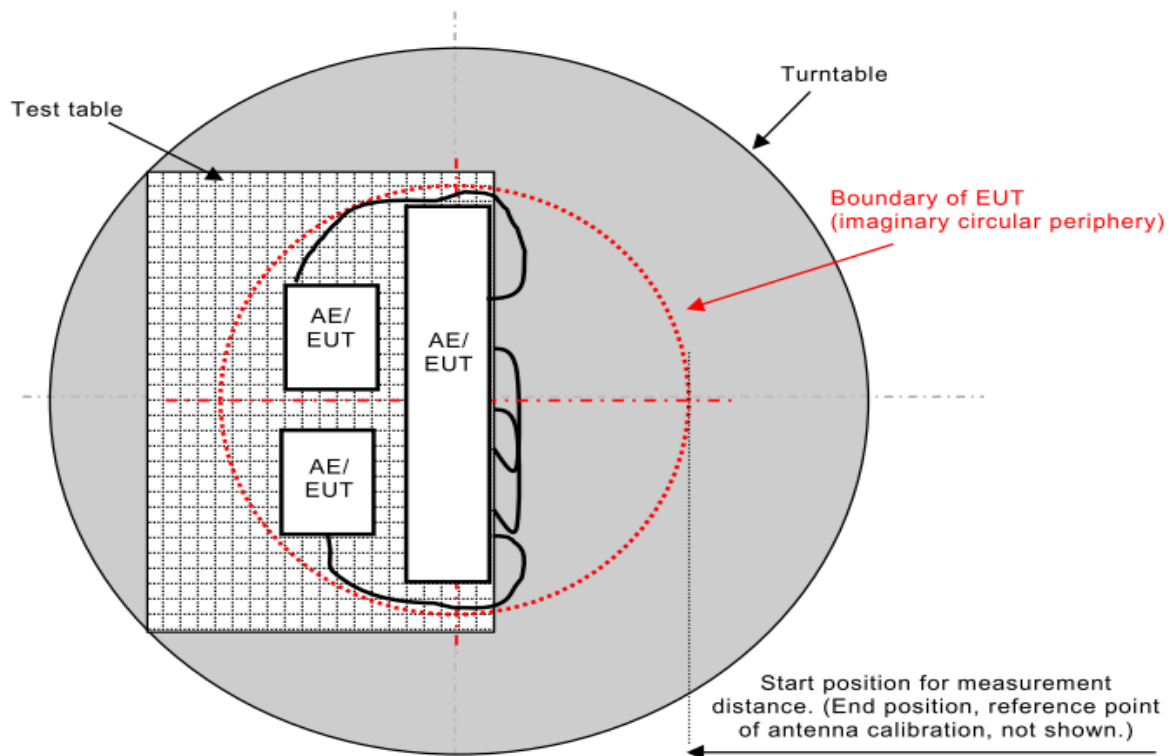

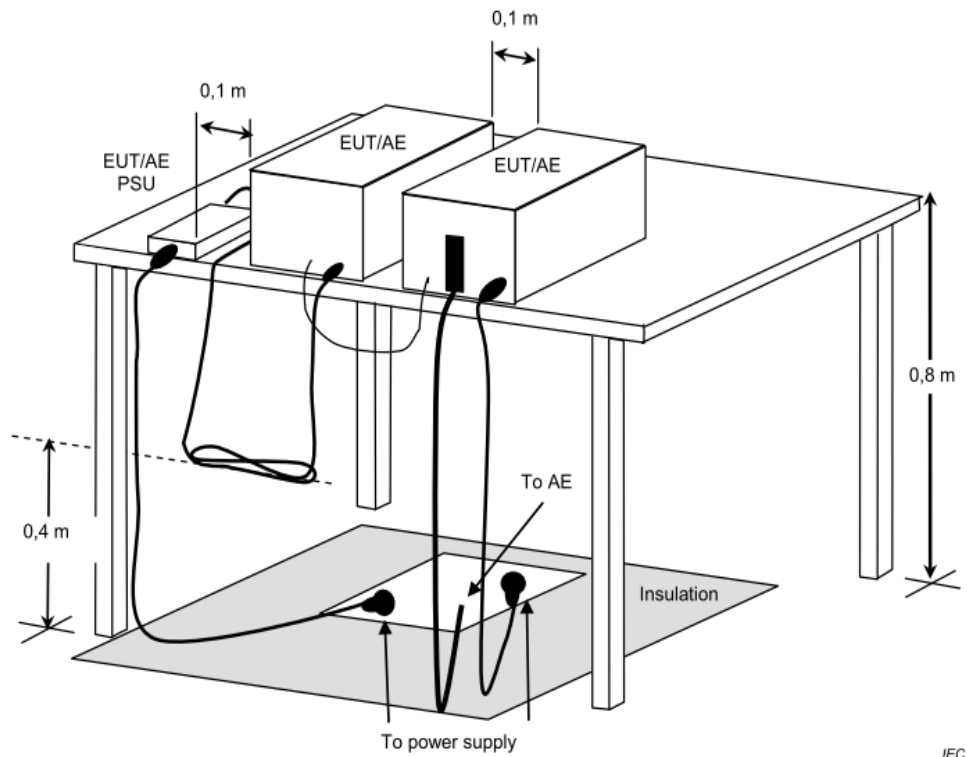
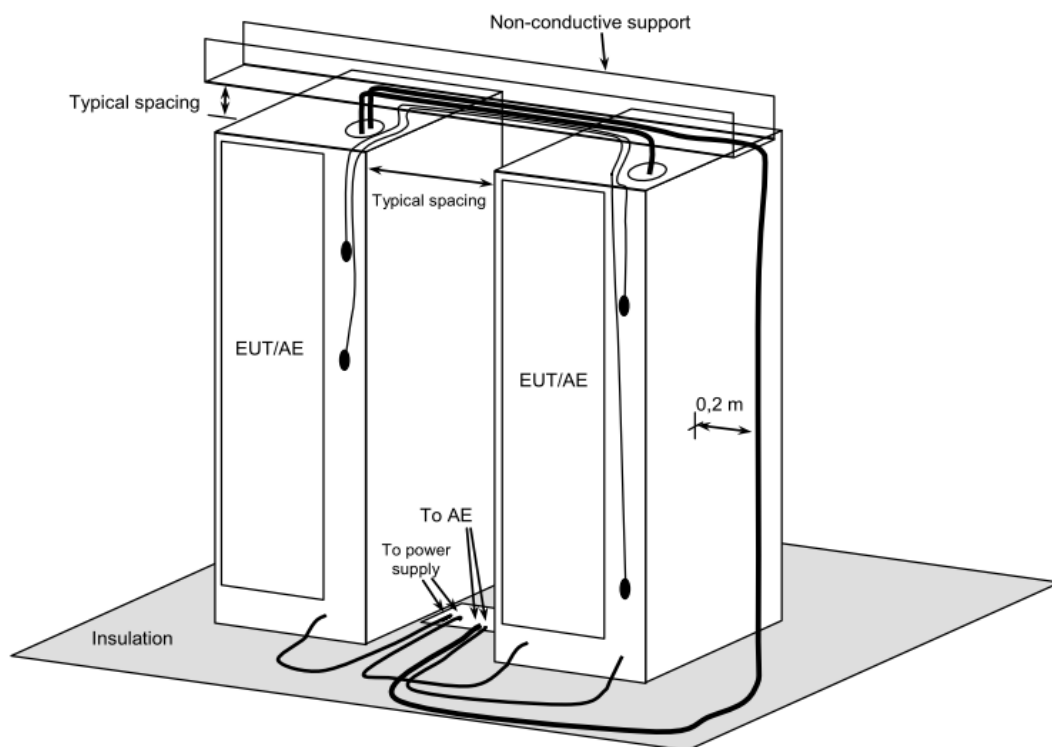
**< Table-Top equipment >****< Floor-Standing equipment >**

**Note:** Please refer to the 4.3.7 for the actual test configuration.



### 4.3.6 Test Result

Test Voltage	230Vac, 50Hz	Frequency Range	30 – 1000 MHz
Environmental Conditions	23°C, 51% RH	6dB Bandwidth	120 kHz
Test Date	2024/02/26	Test Distance	3m
Tested by	Karwin Kao	Polarization	Vertical
Test Site	W08-966-1		

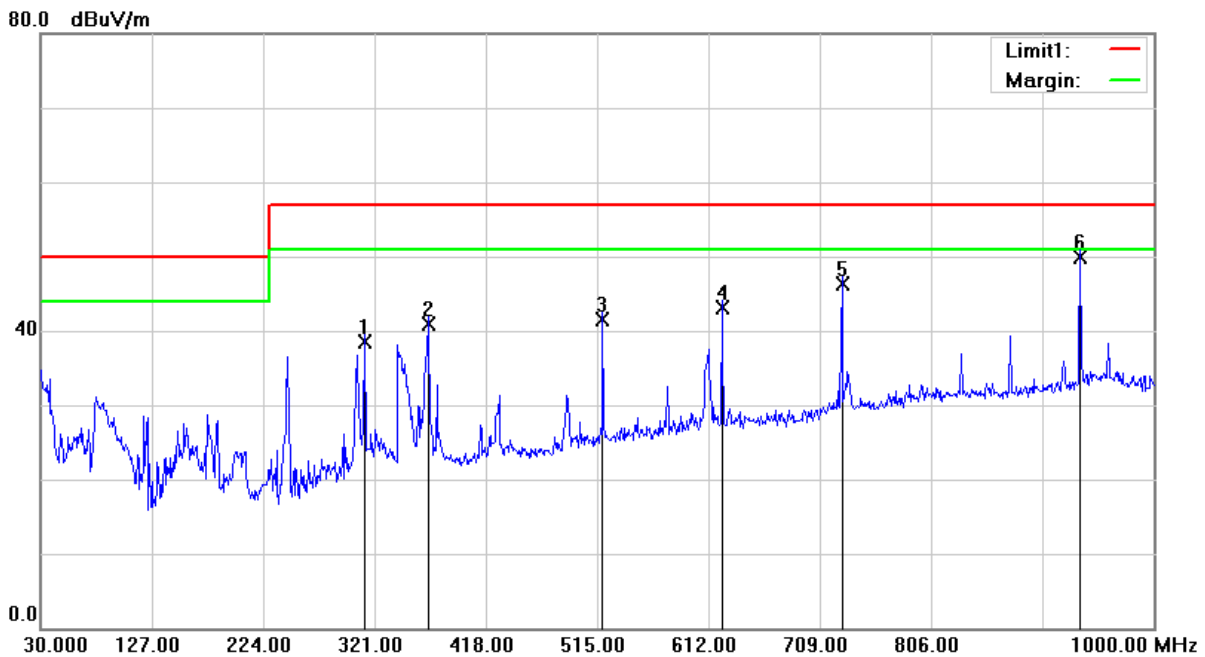

No.	Frequency (MHz)	Reading Level (dBμV)	Correct Factor (dB/m)	Measurement (dBμV/m)	Limit (dBμV/m)	Margin (dB)	Table Degree (degree)	Antenna Height (cm)	Detector
1	312.2700	46.71	-8.20	38.51	57.00	-18.49	184	200	QP
2	367.5600	47.80	-6.92	40.88	57.00	-16.12	184	200	QP
3	519.8500	44.12	-2.69	41.43	57.00	-15.57	188	100	QP
4	623.6400	43.06	0.06	43.12	57.00	-13.88	39	100	QP
5	728.4000	43.98	2.27	46.25	57.00	-10.75	273	100	QP
6	935.9800	44.44	5.54	49.98	57.00	-7.02	317	100	QP

**Remark:** 1. QP = Quasi Peak  
 2. Correction Factor = Antenna factor + Cable loss (Antenna to preamplifier ) - preamplifier Gain + Cable loss (preamplifier to receiver)  
 3. Measurement Value = Reading Level + Correct Factor  
 4. Margin Level = Measurement Value - Limit Value



<b>Test Voltage</b>	230Vac, 50Hz	<b>Frequency Range</b>	30 – 1000 MHz
<b>Environmental Conditions</b>	23°C, 51% RH	<b>6dB Bandwidth</b>	120 kHz
<b>Test Date</b>	2024/02/26	<b>Test Distance</b>	3m
<b>Tested by</b>	Karwin Kao	<b>Polarization</b>	Horizontal
<b>Test Site</b>	W08-966-1		

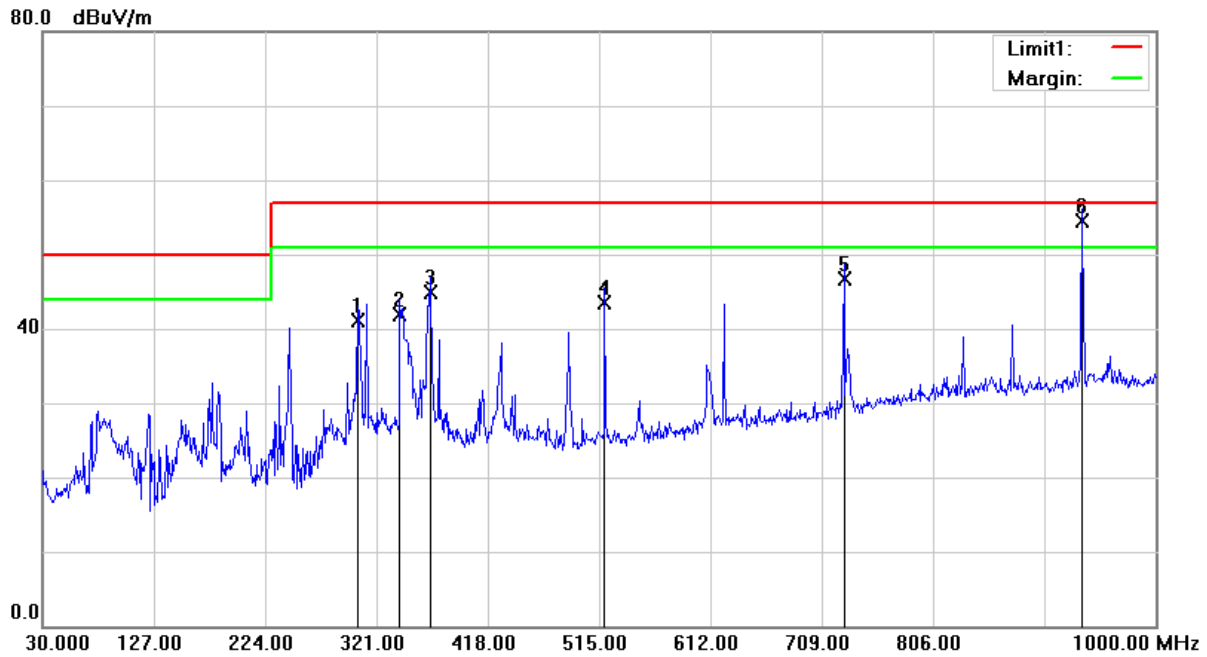

No.	Frequency (MHz)	Reading Level (dB $\mu$ V)	Correct Factor (dB/m)	Measurement (dB $\mu$ V/m)	Limit (dB $\mu$ V/m)	Margin (dB)	Table Degree (degree)	Antenna Height (cm)	Detector
1	304.5100	49.56	-8.52	41.04	57.00	-15.96	306	100	QP
2	341.3700	49.31	-7.44	41.87	57.00	-15.13	52	100	QP
3	367.5600	51.83	-6.92	44.91	57.00	-12.09	73	100	QP
4	519.8500	46.28	-2.69	43.59	57.00	-13.41	266	200	QP
5	728.4000	44.39	2.27	46.66	57.00	-10.34	357	200	QP
6	935.9950	48.90	5.54	54.44	57.00	-2.56	269	100	QP

**Remark:** 1. QP = Quasi Peak  
2. Correction Factor = Antenna factor + Cable loss (Antenna to preamplifier) - preamplifier Gain + Cable loss (preamplifier to receiver)  
3. Measurement Value = Reading Level + Correct Factor  
4. Margin Level = Measurement Value - Limit Value





<b>Test Voltage</b>	230Vac, 50Hz	<b>Frequency Range</b>	1 – 6GHz
<b>Environmental Conditions</b>	23°C, 51% RH	<b>6dB Bandwidth</b>	1MHz
<b>Test Date</b>	2024/02/26	<b>Test Distance</b>	3m
<b>Tested by</b>	Karwin Kao	<b>Polarization</b>	Vertical
<b>Test Site</b>	W08-966-1		

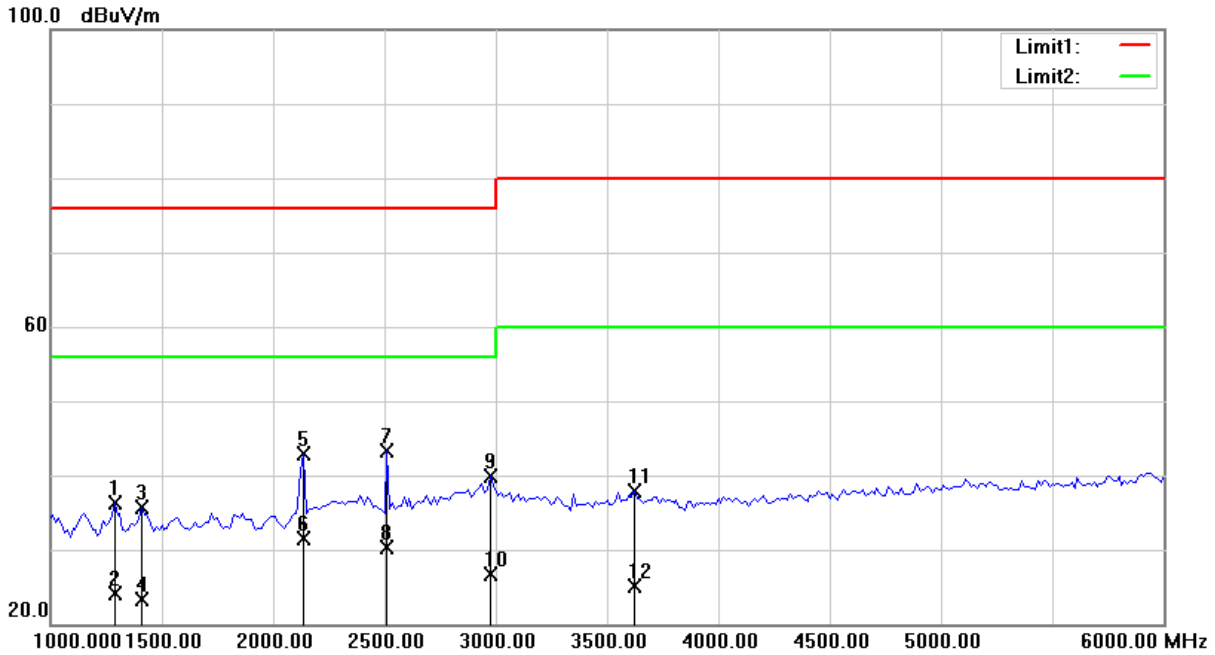

No.	Frequency (MHz)	Reading Level (dBμV)	Correct Factor (dB/m)	Measurement (dBμV/m)	Limit (dBμV/m)	Margin (dB)	Table Degree (degree)	Antenna Height (cm)	Detector
1	1287.500	48.84	-12.61	36.23	76.00	-39.77	113	100	peak
2	1287.500	36.77	-12.61	24.16	56.00	-31.84	113	100	AVG
3	1412.500	47.69	-12.06	35.63	76.00	-40.37	15	100	peak
4	1412.500	35.46	-12.06	23.40	56.00	-32.60	15	100	AVG
5	2137.500	52.43	-9.53	42.90	76.00	-33.10	150	100	peak
6	2137.500	40.98	-9.53	31.45	56.00	-24.55	150	100	AVG
7	2512.500	52.27	-8.98	43.29	76.00	-32.71	317	100	peak
8	2512.500	39.35	-8.98	30.37	56.00	-25.63	317	100	AVG
9	2975.000	46.22	-6.31	39.91	76.00	-36.09	141	100	peak
10	2975.000	33.09	-6.31	26.78	56.00	-29.22	141	100	AVG
11	3625.000	43.08	-5.24	37.84	80.00	-42.16	53	100	peak
12	3625.000	30.28	-5.24	25.04	60.00	-34.96	53	100	AVG

**Remark:** 1. peak = Peak, AVG = Average  
 2. Correction Factor = Antenna factor + Cable loss (Antenna to preamplifier ) - preamplifier Gain + Cable loss (preamplifier to receiver )  
 3. Measurement Value = Reading Level + Correct Factor  
 4. Margin Level = Measurement Value - Limit Value



Test Voltage	230Vac, 50Hz	Frequency Range	1 – 6GHz
Environmental Conditions	23°C, 51% RH	6dB Bandwidth	1MHz
Test Date	2024/02/26	Test Distance	3m
Tested by	Karwin Kao	Polarization	Horizontal
Test Site	W08-966-1		

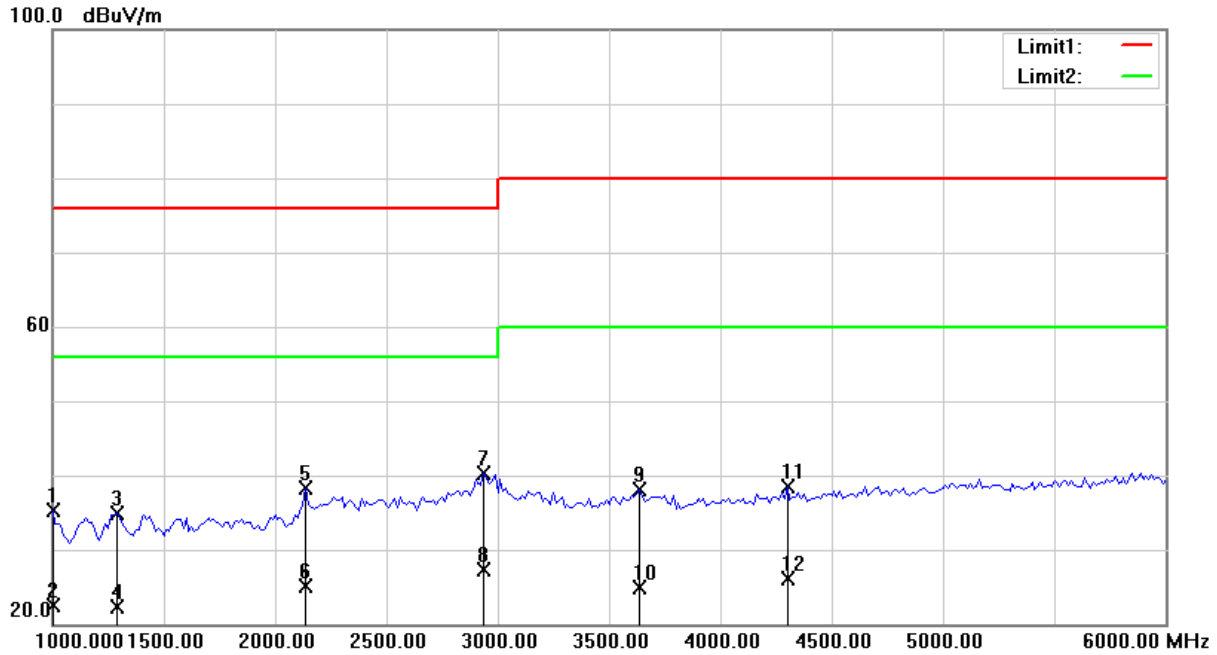

No.	Frequency (MHz)	Reading Level (dBμV)	Correct Factor (dB/m)	Measurement (dBμV/m)	Limit (dBμV/m)	Margin (dB)	Table Degree (degree)	Antenna Height (cm)	Detector
1	1000.0000	50.41	-15.12	35.29	76.00	-40.71	288	100	peak
2	1000.0000	37.54	-15.12	22.42	56.00	-33.58	288	100	AVG
3	1287.500	47.60	-12.61	34.99	76.00	-41.01	93	100	peak
4	1287.500	34.85	-12.61	22.24	56.00	-33.76	93	100	AVG
5	2137.500	47.77	-9.53	38.24	76.00	-37.76	329	100	peak
6	2137.500	34.60	-9.53	25.07	56.00	-30.93	329	100	AVG
7	2937.500	46.84	-6.55	40.29	76.00	-35.71	297	100	peak
8	2937.500	33.88	-6.55	27.33	56.00	-28.67	297	100	AVG
9	3637.500	43.33	-5.23	38.10	80.00	-41.90	181	100	peak
10	3637.500	30.11	-5.23	24.88	60.00	-35.12	181	100	AVG
11	4300.000	42.40	-3.80	38.60	80.00	-41.40	354	100	peak
12	4300.000	29.87	-3.80	26.07	60.00	-33.93	354	100	AVG

**Remark:** 1. peak = Peak, AVG = Average  
 2. Correction Factor = Antenna factor + Cable loss (Antenna to preamplifier ) - preamplifier Gain + Cable loss (preamplifier to receiver )  
 3. Measurement Value = Reading Level + Correct Factor  
 4. Margin Level = Measurement Value - Limit Value

### 4.3.7 Photographs of Test Configuration

#### Radiated Emission Test (30MHz~1GHz)



**Radiated Emission Test (Above 1GHz)**

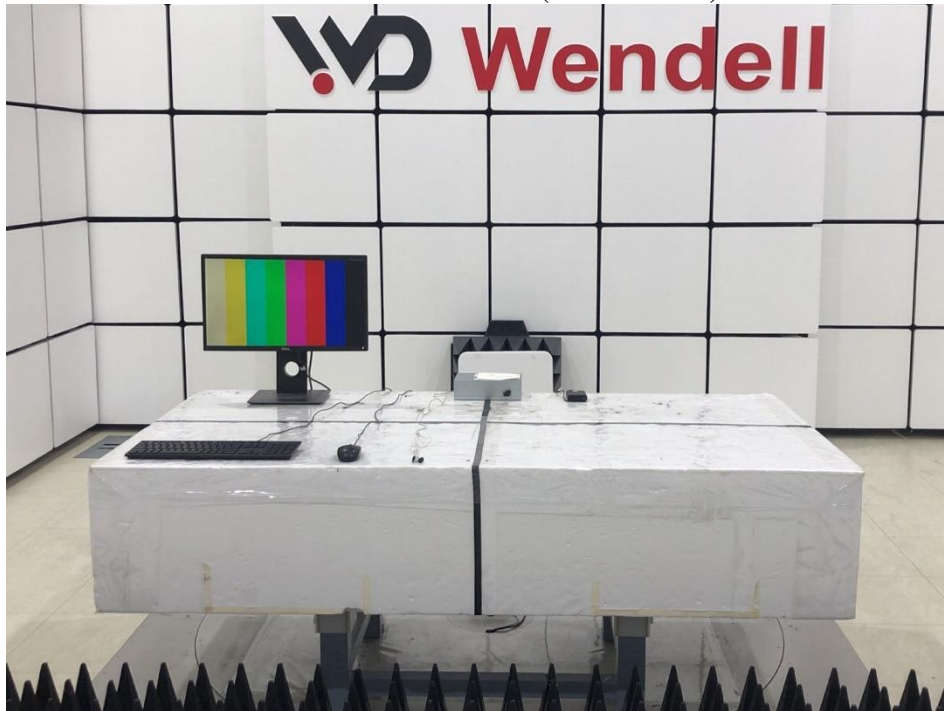

## 4.4 Harmonics Current Measurement

### 4.4.1 Limits of Harmonics Current Measurement

The limits ensure that harmonic disturbance levels do not exceed the compatibility levels defined in IEC 61000-3-2.

Limits for Class A equipment	
Harmonics Order n	Max. permissible harmonics current A
Odd harmonics	
3	2.30
5	1.14
7	0.77
9	0.40
11	0.33
13	0.21
15<=n<=39	0.15x15/n
Even harmonics	
2	1.08
4	0.43
6	0.30
8<=n<=40	0.23x8/n

Limits for Class D equipment		
Harmonics Order n	Max. permissible harmonics current per watt mA/W	Max. permissible harmonics current A
Odd Harmonics only		
3	3.4	2.30
5	1.9	1.14
7	1.0	0.77
9	0.5	0.40
11	0.35	0.33
13	0.30	0.21
15<=n<=39	3.85/n	0.15x15/n

- Note:** 1. Class A and Class D are classified according to item section 5 of EN 61000-3-2.  
 2. According to section 7 of EN 61000-3-2, the above limits for all equipment except for lighting equipment having an active input power > 75 W and no limits apply for equipment with an active input power up to and including 75 W.

### 4.4.2 Test Instrument

Item	Equipment	Manufacturer	Model	Meter No.	Calibration Date
1	Harmonics & Flicker Analyser	EMC PARTNER	HAR-1000-1P	CT-1-090(1)	Oct. 19, 2023
2	Power Source	EMC PARTNER	PS3-1	CT-1-090a1	Oct. 19, 2023

- Note:** 1. The calibration interval of the above test instruments is 12 months.

### 4.4.3 Test Procedure

The table-top EUT was placed on the top of a wooden table 0.8 meter above the ground and operated to produce the maximum harmonic under normal operating conditions for each successive harmonic component in turn. The floor-standing EUT was placed insulation support unit from the horizontal ground plane.

The classification of EUT is according to section 5 of EN 61000-3-2.

The EUT classified as follows:

Class A:

- Balanced three-phase equipment;
- Household appliances excluding equipment identified as Class D;
- Tools excluding portable tools;
- Dimmers for incandescent lamps;
- Audio equipment.

Equipment not specified in one of the three other classes should be considered as Class A equipment.

Note 1: Equipment that can be shown to have a significant effect on the supply system may be reclassified in a future edition of the standard. Factors to be taken into account include:

- Number in use;
- Duration of use;
- Simultaneity of use;
- Power consumption;
- Harmonic spectrum, including phase.

Class B:

- Portable tools;
- Arc welding equipment, which is not professional equipment.

Class C:

- Lighting equipment;

Class D:

Equipment having a specified power according to 6.2.2 less than or equal to 600W, of the following types:

- Personal computers and personal computer monitors;
- Television receivers.
- Refrigerators and freezers having one or more variable-speed drives to control compressor motor(s).

#### 4.4.4 Deviation from Test Standard

No deviation

#### 4.4.5 Test Setup

< Table-Top equipment >

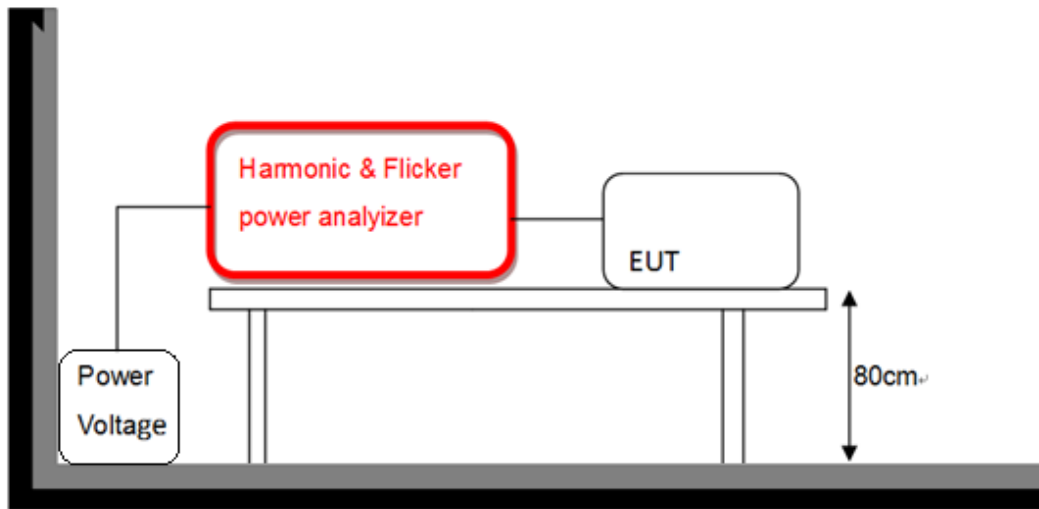

< Floor-Standing equipment >

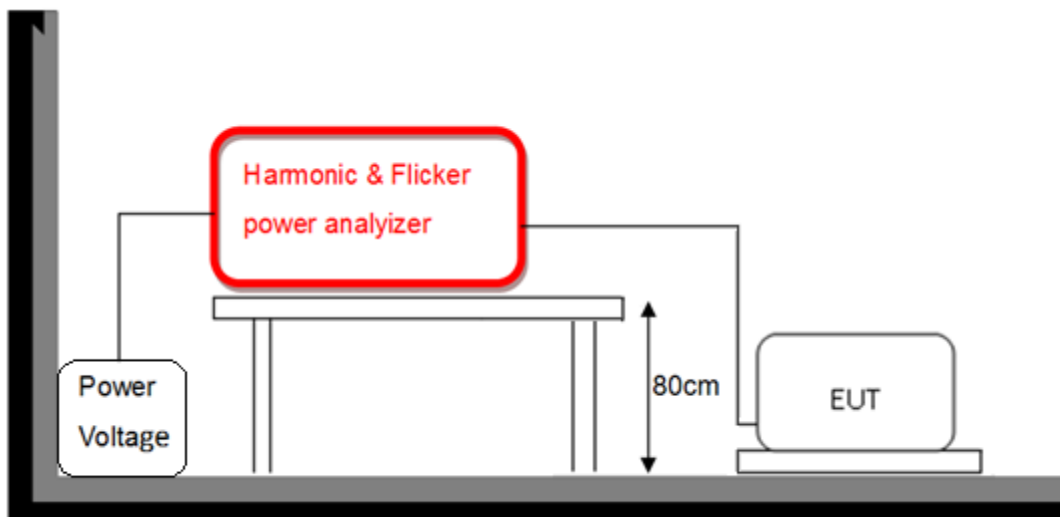



#### 4.4.6 Test Result

<b>Supply Voltage / Ampere</b>	229.5 V <sub>rms</sub> / 0.290 A <sub>rms</sub>	<b>Test Date</b>	2024/02/29
<b>Test Duration</b>	5 min	<b>Power Consumption</b>	23.51W
<b>Power Frequency</b>	49.935Hz	<b>Power Factor</b>	0.353
<b>Environmental Conditions</b>	22°C, 49% RH	<b>Tested by</b>	Guanwei Liao

**Note:**

1. Limits are not specified for equipment with a rated power of 75W or less (other than lighting equipment).
2. According to EN 61000-3-2 the manufacturer shall specify the power of the apparatus. This value shall be used for establishing limits. The specified power shall be within +/-10% of the measured power.



#### 4.4.7 Photographs of Test Configuration

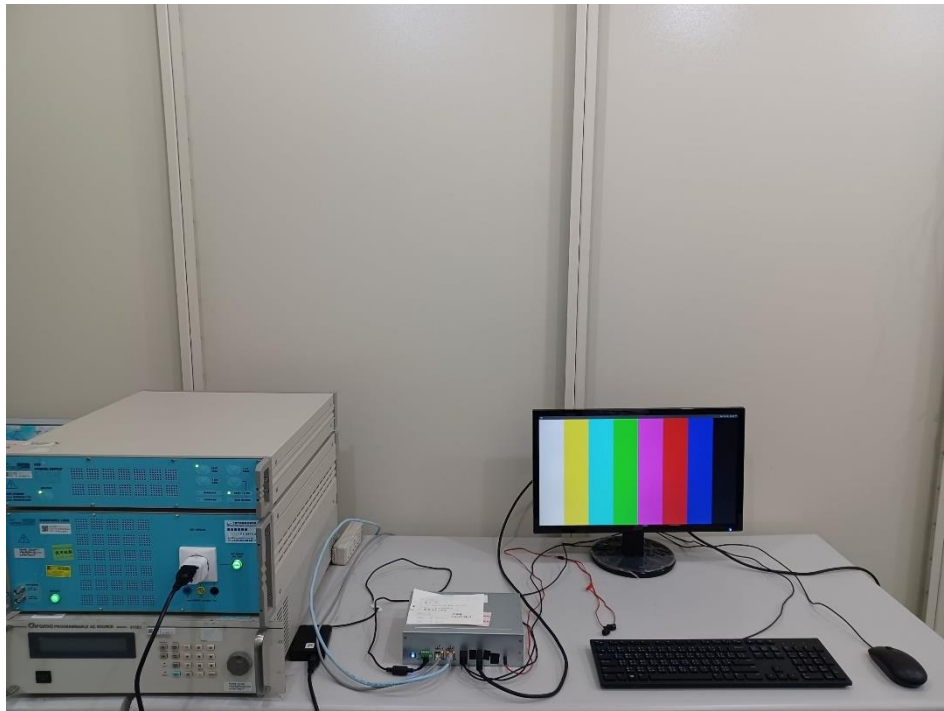

## 4.5 Voltage Fluctuation and Flicker Measurement

### 4.5.1 Limit for Voltage Function and Flicker Measurement

Tests Item	Limits	Remark
	IEC/EN 61000-3-3	
P <sub>st</sub>	1.0, T <sub>p</sub> = 10 min.	P <sub>st</sub> means short-term flicker
P <sub>lt</sub>	0.65, T <sub>p</sub> =2 hr.	P <sub>lt</sub> means long-term flicker
dc (%)	3.3%	dc means relative steady-state voltage change
d <sub>max</sub> (%)	4%	d <sub>max</sub> means maximum relative voltage change.
T <sub>dt</sub>	3.3% / 500 ms	T <sub>dt</sub> means maximum time that dt exceeds 3.3 %.

### 4.5.2 Test Instrument

Item	Equipment	Manufacturer	Model	Meter No.	Calibration Date
1	Harmonics & Flicker Analyser	EMC PARTNER	HAR-1000-1P	CT-1-090(1)	Oct. 19, 2023
2	Power Source	EMC PARTNER	PS3-1	CT-1-090a1	Oct. 19, 2023

**Note:** 1. The calibration interval of the above test instruments is 12 months.

### 4.5.3 Test Procedure

The table-top EUT was placed on the top of a wooden table 0.8 meter above the ground and operated to produce the most unfavorable sequence of voltage changes under normal operating condition. The floor-standing EUT was placed insulation support unit from the horizontal ground plane.

During the flick measurement, the measure time shall include that part of whole operation cycle in which the EUT produce the most unfavorable sequence of voltage changes. The observation period for short-term flicker indicator is 10 min and the observation period for long-term flicker indicator is 2 hours.

### 4.5.4 Deviation from Test Standard

No deviation

### 4.5.5 Test Setup

< Table-Top equipment >

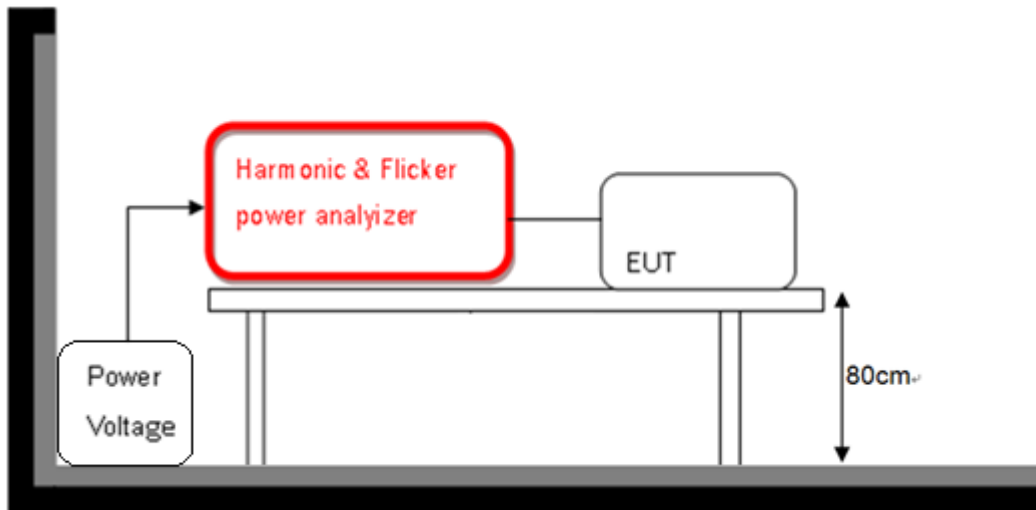

< Floor-Standing equipment >

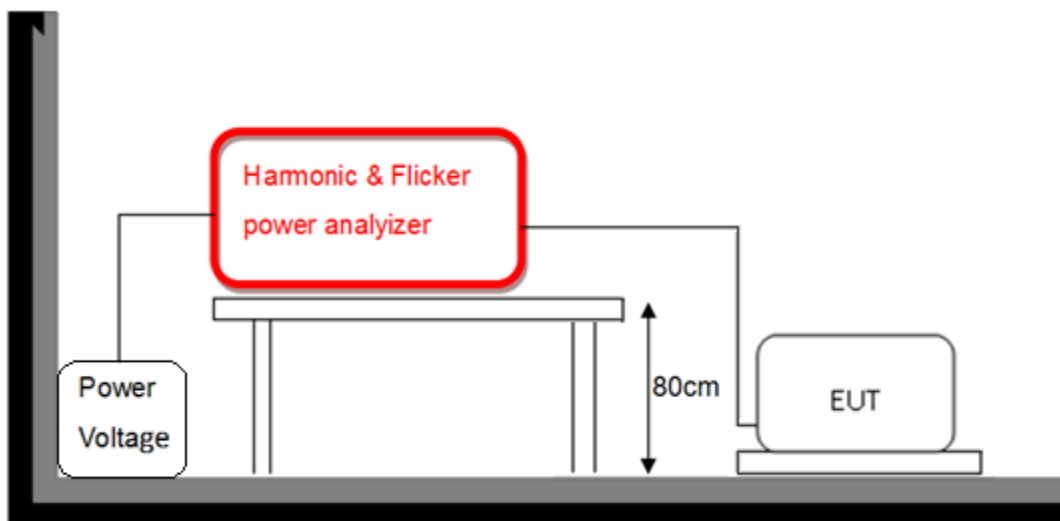



#### 4.5.6 Test Result

<b>Supply Voltage / Ampere</b>	229.5 Vrms / 0.260 Arms	<b>Test Date</b>	2024/02/29
<b>Observation (Tp)</b>	30 min	<b>Environmental Conditions</b>	22°C, 49% RH
<b>Power Frequency</b>	49.935Hz	<b>Tested by</b>	Guanwei Liao

<b>Test Parameter</b>	<b>Measurement Value</b>	<b>Test Limit</b>	<b>Remarks</b>
P <sub>st</sub>	0.07	1.00	Pass
P <sub>lt</sub>	0.07	0.65	Pass
T <sub>dt</sub> (ms)	0.00	500	Pass
d <sub>max</sub> (%)	0.00	4%	Pass
dc (%)	0.02	3.3%	Pass

- Note:**
1. P<sub>st</sub> means short-term flicker indicator.
  2. P<sub>lt</sub> means long-term flicker indicator.
  3. T<sub>dt</sub> means maximum time that dt exceeds 3.3 %.
  4. d<sub>max</sub> means maximum relative voltage change.
  5. dc means relative steady-state voltage change.

### 4.5.7 Photographs of Test Configuration

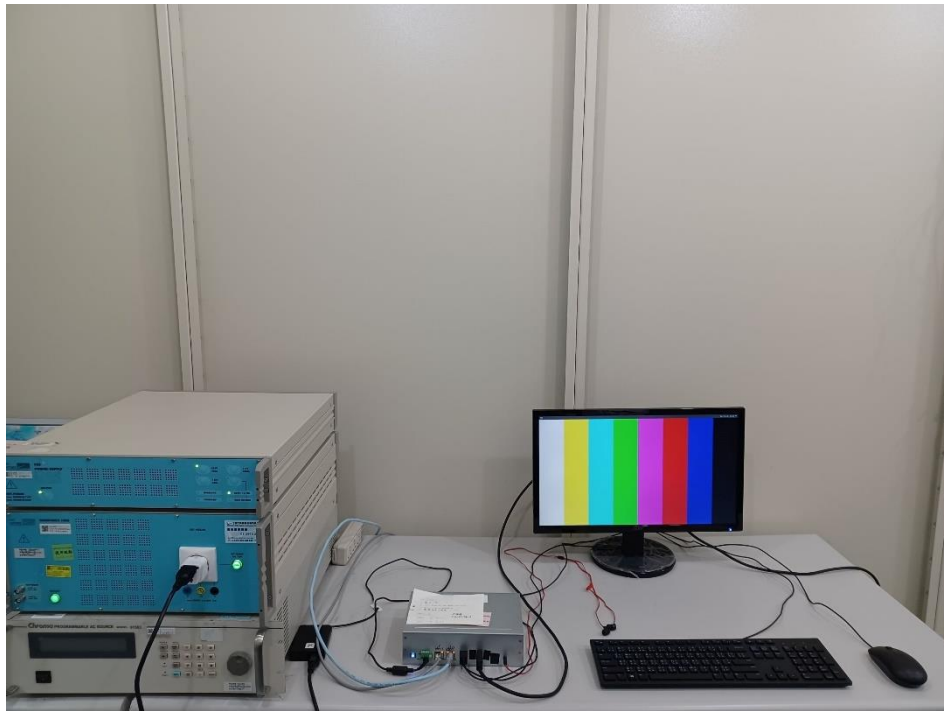

## 5 Immunity Test

### 5.1 Standard Description

Product standard	EN 55035	
<b>Basic Standard and Performance Criterion required</b>	IEC 61000-4-2 (ESD)	±4 kV Contact discharge, ±8 kV Air discharge, Performance Criterion B
	IEC 61000-4-3 (RS)	80 M ~ 1000 MHz, 3V/m(rms) , 80% AM (1kHz), 1800 MHz, 2600 MHz, 3500 MHz, 5000 MHz for spot test (Wireless communication device), 3V/m(rms), 80% AM (1kHz), Performance Criterion A
	IEC 61000-4-4 (EFT)	AC Main Power Port: ±1kV, DC Network Power Port (cable length > 3m): ±0.5 kV, Analogue/Digital Data Ports (cable length > 3m): ±0.5 kV, Performance Criterion B
	IEC 61000-4-5 (Surge)	AC Main Power Port: line to line ±1 kV, line to ground ±2 kV, DC Network Power Port (cable length > 3m): line to ground ±0.5 kV, Performance Criteria B Analogue/Digital Data Ports (unshielded symmetrical):line to ground Primary Protection: Intended, ±1 kV and ±4 kV, Primary Protection: Not Intended, ±1 kV, Performance Criteria C Analogue/Digital Data Ports (coaxial or shielded): shielded to ground, ±0.5 kV, Performance Criteria B
	IEC 61000-4-6 (CS)	AC Main Power Port, DC Network Power Port (cable length > 3m), Analogue/Digital Data Ports (cable length > 3m), 0.15 M ~ 10 MHz, 3Vrms, 80% AM, 1kHz, 10 M ~ 30 MHz, 3 - 1Vrms, 80% AM, 1kHz, 30 M ~ 80 MHz, 1Vrms, 80% AM, 1kHz, Performance Criterion A
	IEC 61000-4-8 (PFMF)	50Hz or 60Hz, 1 A/m, Performance Criterion A
	IEC 61000-4-11 (Dips)	Voltage Dips: >95% reduction, 0.5 period, Performance Criterion B 30% reduction, 25 period, Performance Criterion C Voltage Interruptions: >95% reduction, 250 period, Performance Criterion C

## 5.2 Performance Criteria

According to Clause 8 of EN 55035 standard, the general performance criteria as following:

<b>Criteria A</b>	The equipment shall continue to operate as intended without operator intervention. No degradation of performance, loss of function or change of operating state is allowed below a performance level specified by the manufacturer when the equipment is used as intended. The performance level may be replaced by a permissible loss of performance. If the minimum performance level or the permissible performance loss is not specified by the manufacturer, then either of these may be derived from the product description and documentation, and by what the user may reasonably expect from the equipment if used as intended.
<b>Criteria B</b>	During the application of the disturbance, degradation of performance is allowed. However, no unintended change of actual operating state or stored data is allowed to persist after the test. After the test, the equipment shall continue to operate as intended without operator intervention. No degradation of performance or loss of function is allowed, below a performance level specified by the manufacturer, when the equipment is used as intended. The performance level may be replaced by a permissible loss of performance. If the minimum performance level (or the permissible performance loss), or recovery time is not specified by the manufacturer, then either of these may be derived from the product description and documentation, and by what the user may reasonably expect from the equipment if used as intended.
<b>Criteria C</b>	Loss of function is allowed, provided the function is self-recoverable, or can be restored by the operation of the controls by the user in accordance with the manufacturer's instructions. A reboot or re-start operation is allowed. Information stored in non-volatile memory, or protected by a battery backup, shall not be lost.

### 5.3 Electrostatic Discharge (ESD)

#### 5.3.1 Test Specification

<b>Standard</b>	IEC/EN 61000-4-2
<b>Discharge Impedance</b>	330 ohm / 150 pF
<b>Discharge Voltage</b>	Air Discharge: $\pm 2, \pm 4, \pm 8$ kV (Direct) Contact Discharge: $\pm 4$ kV (Direct/Indirect)
<b>Number of Discharge</b>	Air: Minimum 10 times at each point. Contact: Minimum 10 times at each points
<b>Discharge Mode</b>	Single Discharge
<b>Discharge Period</b>	1 second minimum

#### 5.3.2 Test Instrument

Item	Equipment	Manufacturer	Model	Meter No.	Calibration Date
1	ESD Generator	TESEQ	NSG 437	CT-1-140	Sep. 25, 2023
2	ESD Generator	NoiseKen	ESS-B3011	CT-1-089	Aug. 04, 2023
3	Digital Thermo-Hygro Meter	N/A	HTC-8	CT-2-047	Jun. 06, 2023
4	Atmosphere pressure meter	TES	TES-1161	CT-5-094	Aug. 10, 2023

- Note:** 1. The calibration interval of the test instruments is 12 months.  
2. The calibration interval of thermo hygrometer/ Atmosphere pressure meter is 24 months.



### 5.3.3 Test Procedure

The test generator necessary to perform direct and indirect application of discharge to the EUT in following methods:

a. Contact discharges to the conductive surface and coupling planes:

For table-top equipment one of the test points shall be the centre front edge of the horizontal coupling plane, which shall be subjected to at least 20 indirect discharges (10 of each polarity). All other test points shall each receive at least 20 direct contact discharges (10 of each polarity). All areas normally touched by the user should be tested. Test shall be performed at a maximum repetition rate of one discharge per second.

**Vertical Coupling Plane (VCP):**

The coupling plane, of dimensions 0.5 m × 0.5 m, is placed parallel to, and positioned at a distance 0.1 m from, the EUT, with the discharge electrode touching the coupling plane. The four faces of the EUT will be performed with electrostatic discharge.

**Horizontal Coupling Plane (HCP):**

The coupling plane, of dimensions 1.6 m × 0.8 m, is placed under the EUT. The generator shall be positioned vertically a distance of 0.1 m from the EUT, with the discharge electrode touching the coupling plane. The four faces of the EUT will be performed with electrostatic discharge.

b. Air discharge at apertures and slots and insulating surface:

On those parts of the EUT where it is not possible to perform contact discharge testing, the equipment should be investigated to identify user accessible points where breakdown may occur. Such points are tested using the air discharge method. This investigation should be restricted to those area normally handled by the user. A minimum 10 single air discharges shall be applied to the selected test point for each such area.

### 5.3.4 Deviation from Test Standard

No deviation

### 5.3.5 Test Setup

< Table-Top equipment >

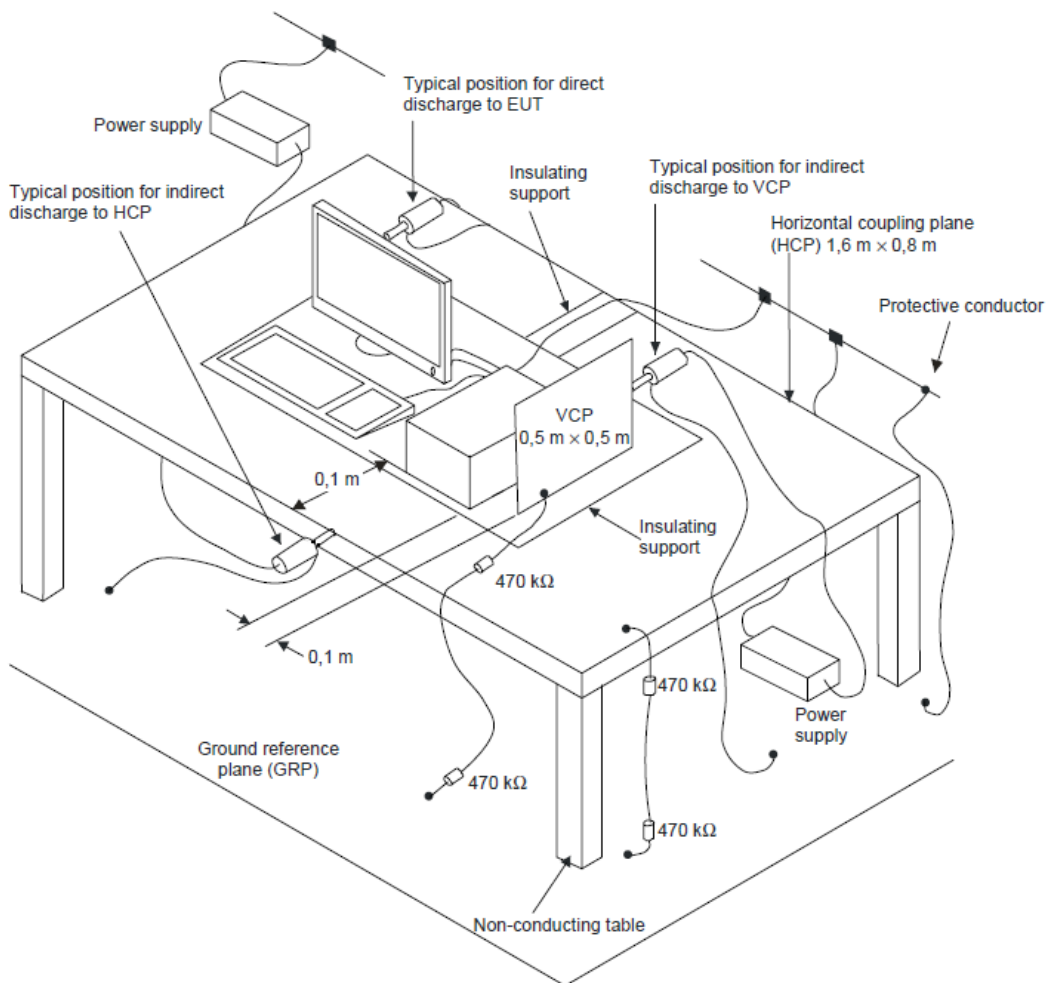

### < Floor-Standing equipment >

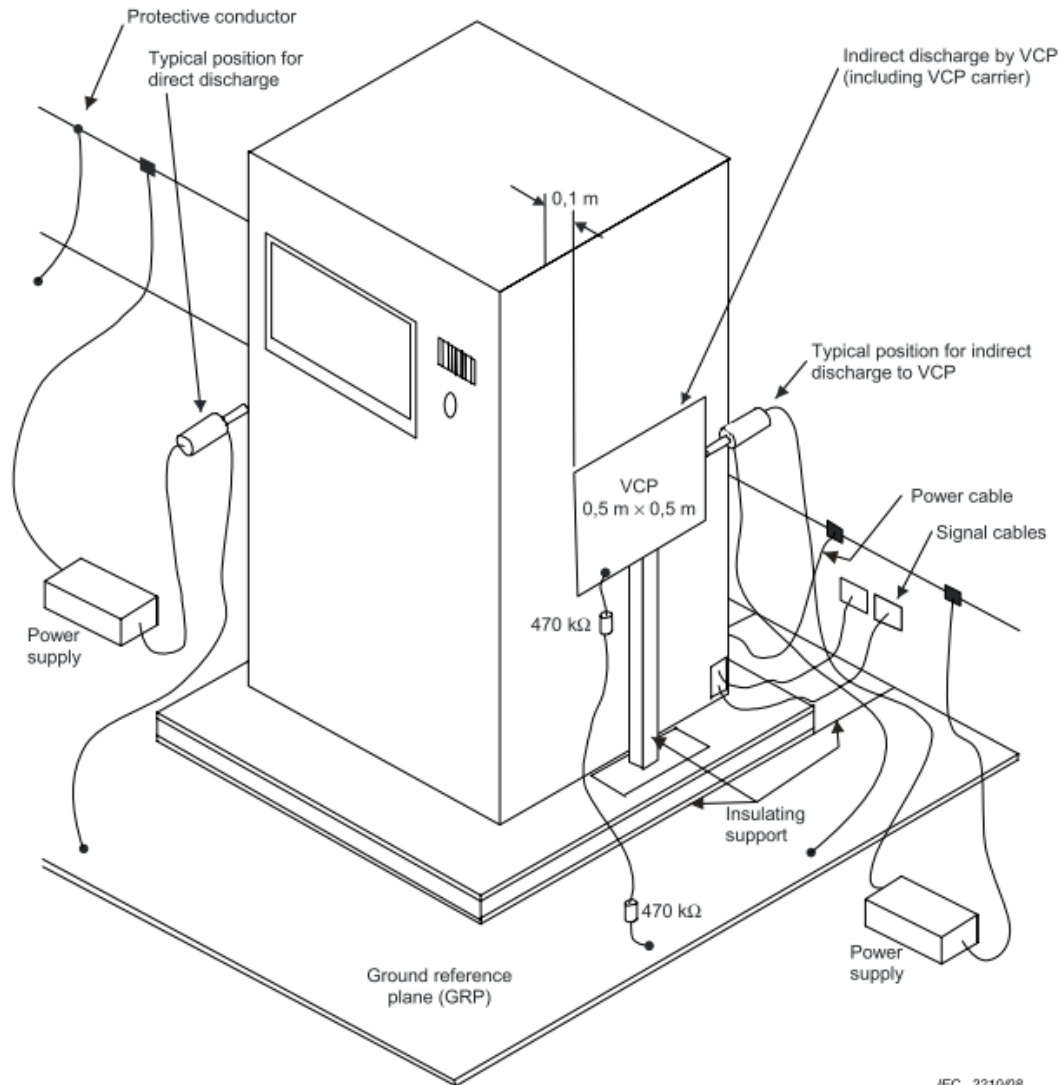

IEC 2210/08



### 5.3.6 Test Result

<b>Test Voltage</b>	230Vac, 50Hz	<b>Test Date</b>	2024/03/04
<b>Environmental Conditions</b>	17°C, 42% RH	<b>Pressure</b>	1008 mbar
<b>Tested by</b>	Guanwei Liao		

#### Test Results of Direct Application

Air Discharge				
Test Point	Discharge Level (kV)			Result
	±2	±4	±8	
Front	N/A	N/A	N/A	N/A
Back	A	A	A	A
Left	N/A	N/A	N/A	N/A
Right	N/A	N/A	N/A	N/A
Top	N/A	N/A	N/A	N/A
Bottom	N/A	N/A	N/A	N/A
Other	N/A	N/A	N/A	N/A

\* Test location(s) in which discharge to be applied illustrated by photos shown in next page(s).

Contact Discharge			
Test Point	Discharge Level (kV)		Result
	±4		
Front	A		A
Back	A		A
Left	A		A
Right	A		A
Top	A		A
Bottom	A		A
Other	N/A		N/A

\* Test location(s) in which discharge to be applied illustrated by photos shown in next page(s).

**Test Results of Indirect Application**

HCP Discharge		
Test Point	Discharge Level (kV)	Result
	±4	
Front	A	A
Back	A	A
Left	A	A
Right	A	A

VCP Discharge		
Test Point	Discharge Level (kV)	Result
	±4	
Front	A	A
Back	A	A
Left	A	A
Right	A	A

**Note:**

N/A: Not applicable

Criteria A: The EUT function was correct during the test.

Criteria A: (#1) No occur arcing.

### Description of Test Points

Front

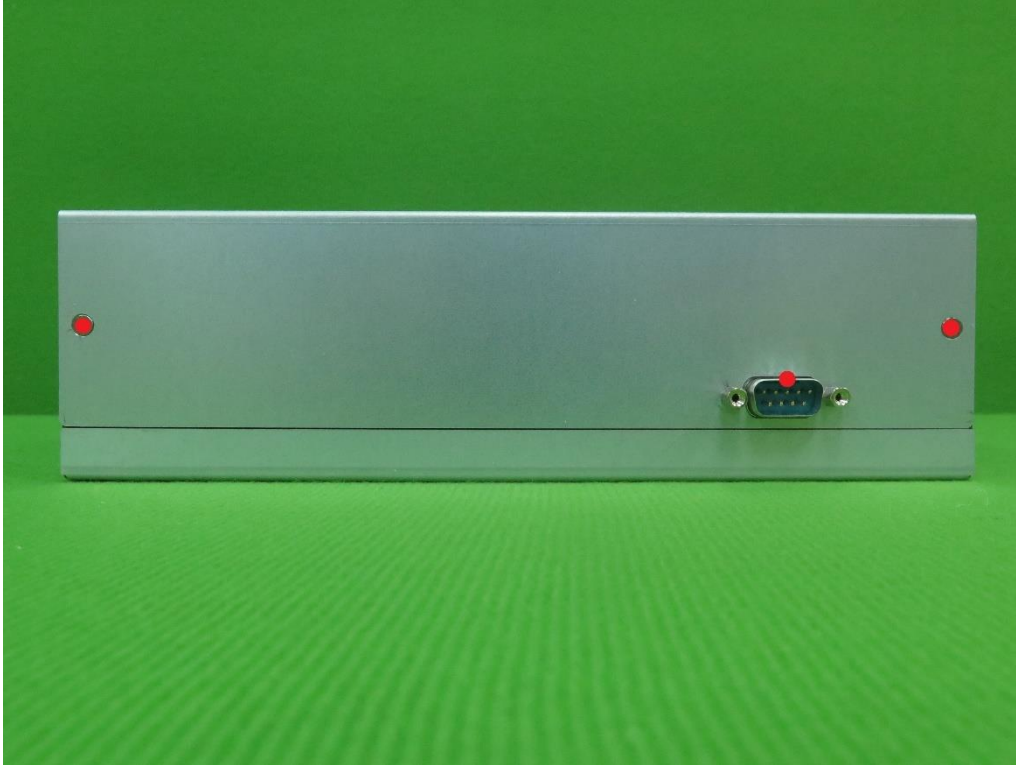

Back



\*Red Dot - Contact Discharged  
Blue Dot - Air Discharged

Left

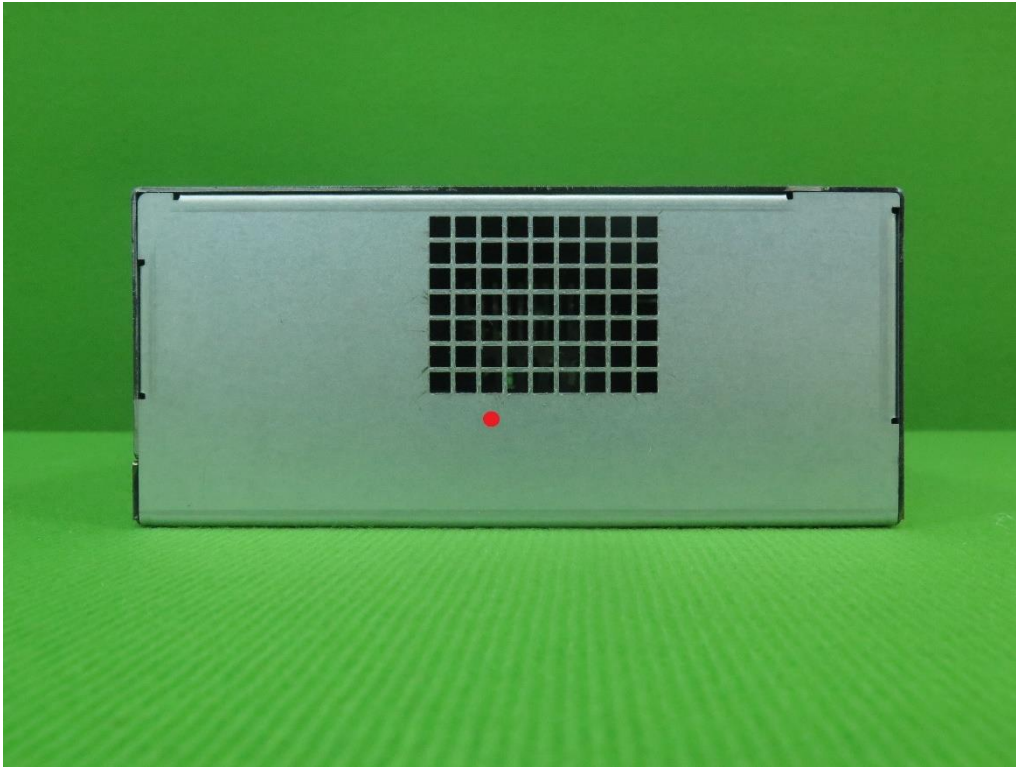

Right

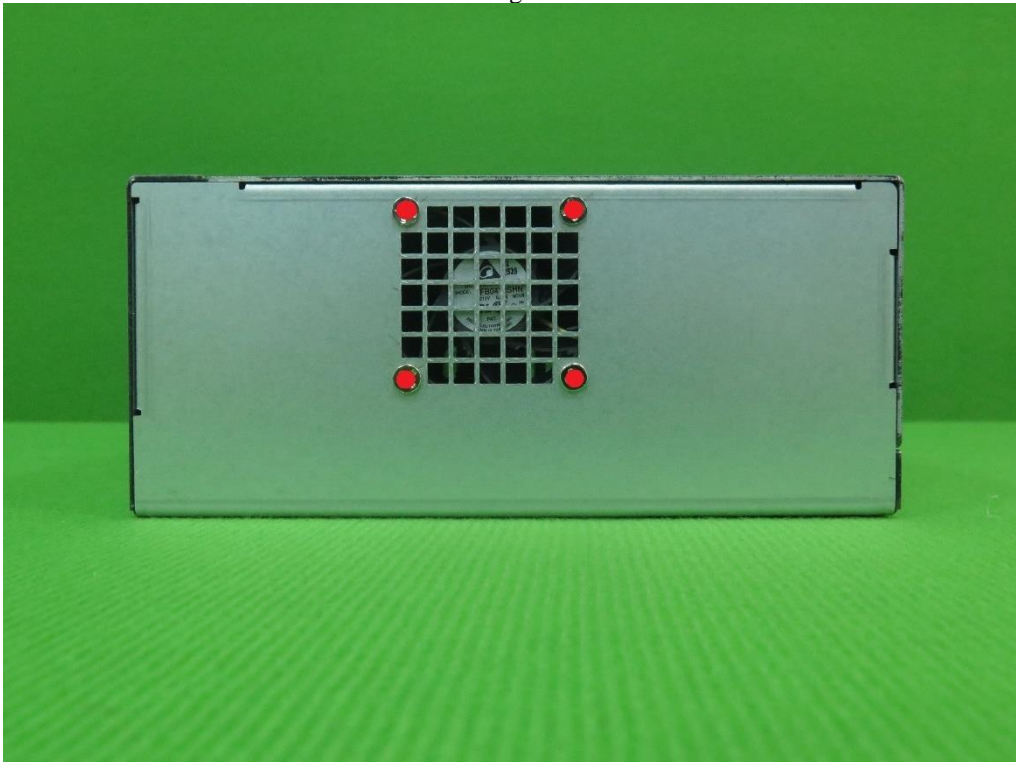

\*Red Dot - Contact Discharged  
Blue Dot - Air Discharged

Top

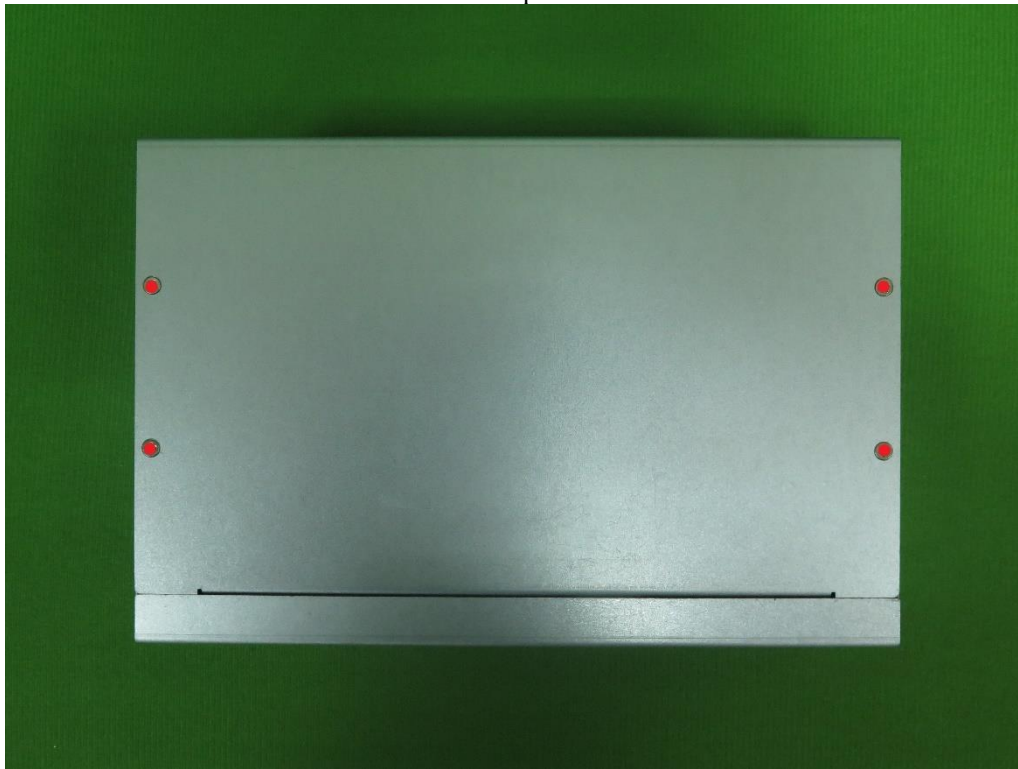

Bottom

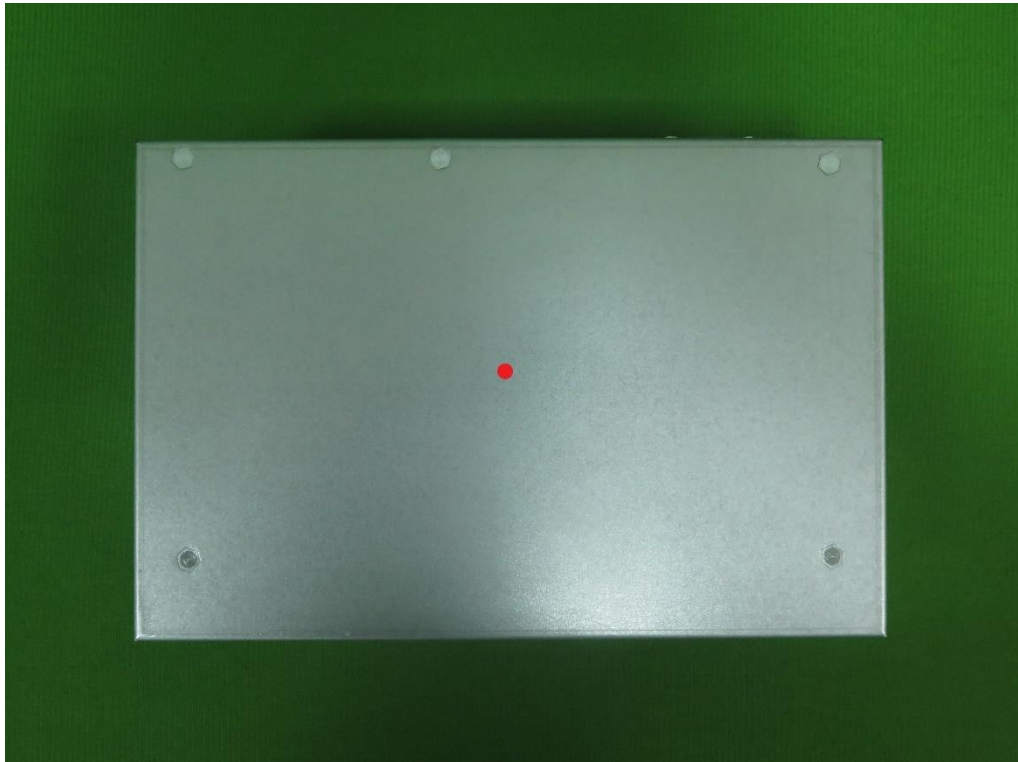

\*Red Dot - Contact Discharged  
Blue Dot - Air Discharged



### 5.3.7 Photographs of Test Configuration

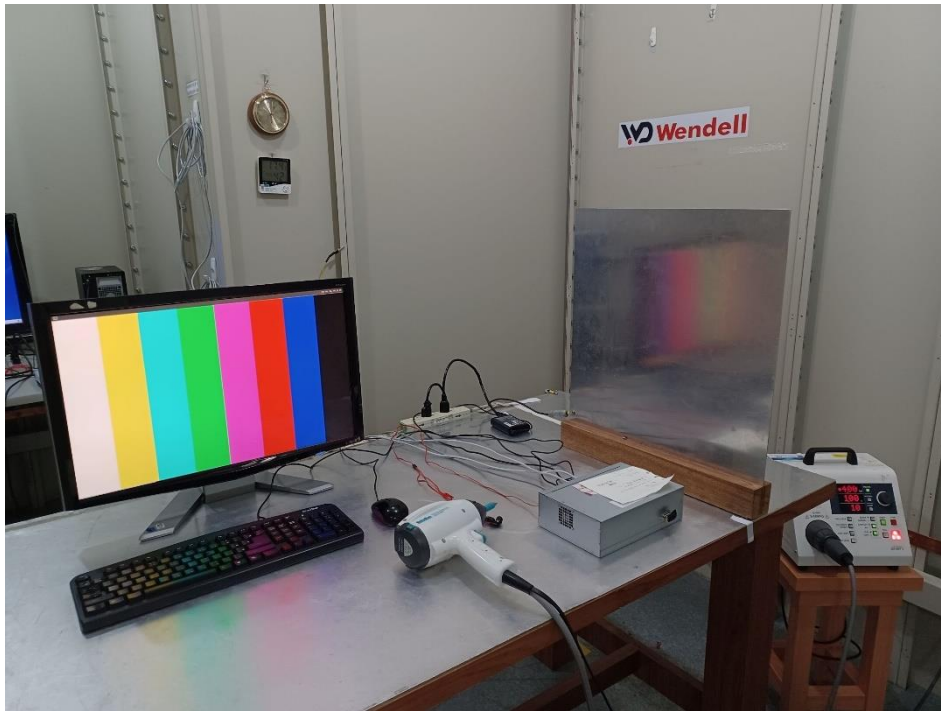

## 5.4 Radiated, Radio-frequency, Electromagnetic Field Immunity Test (RS)

### 5.4.1 Test Specification

<b>Standard</b>	IEC/EN 61000-4-3
<b>Frequency Range</b>	80MHz - 1000MHz 1800MHz, 2600MHz, 3500MHz, 5000MHz for spot test
<b>Field Strength</b>	3 V/m
<b>Modulation</b>	80%, AM Modulation 1 kHz Sine Wave
<b>Frequency Step</b>	1%
<b>Polarity of Antenna</b>	Horizontal and Vertical
<b>Test Distance</b>	2.5 m & 1 m
<b>Antenna Height</b>	1.5 m & 1 m
<b>Dwell Time</b>	3 seconds or not exceed 5 seconds

### 5.4.2 Test Instrument

Item	Equipment	Manufacturer	Model	Meter No.	Calibration Date
1	RadiCentre ® Modular EMC Test Systems	DARE	CTR1004B	CT-1-080	No calibration request
2	RF Signal Generator	DARE	RGN6000B	CT-1-080	Aug. 06, 2023
3	LINEAR POWER RF AMPLIFIER	TESEQ	CBA1G-300 D	CT-1-163	Aug. 06, 2023
4	LINEAR POWER RF AMPLIFIER	OPHIR	5193	CT-1-083	Aug. 06, 2023
5	LINEAR POWER RF AMPLIFIER	FRANKONIA	FLG-30C	CT-1-061	Aug. 06, 2023
6	Periodic Test-Antenna	Schwarzbeck Mess - Elektronik	STLP 9128 E	CT-1-085	No calibration request
7	Stacked Microwave Log.-Per. Antenna	Schwarzbeck Mess - Elektronik	STLP 9149	CT-1-086	No calibration request
8	Electric Field Probe	FRANKONIA	EFS-10	CT-1-060a1	Sep. 29, 2023
9	Measurement Software	EMC-RS	Ver: 2.0.1.3	N/A	No calibration request
10	Conditioning Amplifier / Microphone	B & K	2690-OS2 / 4192-L-001	CT-1-157	May 25, 2023
11	Sound Level Calibrator	B & K	4231	CT-1-156	Jun. 01, 2023
12	Sound Analyer	VGT	ABT CB0	CT-1-159	May 31, 2023
13	Frequency Counter	HEWLETT PACKARD	53181A	CT-1-158	May 28, 2023
14	Audio output Measurement Software	VGT	V1.2-WD	N/A	No calibration request

**Note:** 1. The calibration interval of the above test instruments is 12 months.

### 5.4.3 Test Procedure

The test procedure was in accordance with IEC 61000-4-3.

The table-top EUT and load, which are placed on a table that is 0.8 meter above ground, are placed with one coincident with the calibration plane such that the distance from antenna to the EUT was 3 meters.

Both horizontal and vertical polarization of the antenna and four sides of the EUT are set on measurement.

The EUT shall be positioned so that the four sides of the EUT shall be exposed to the electromagnetic field in sequence. In each position the performance of the EUT will be investigated.

In the case where the most sensitive surface side of the EUT is known throughout the frequency range (for example, via preliminary tests), testing may be restricted to that surface side only. Where it is not possible to determine the most sensitive face with any certainty (for example where different faces are sensitive at different frequencies) all four faces shall be tested.

If the EUT is too large such that it cannot be fully illuminated by the radiating antenna, or exceeds the size of the Uniform Field Area (UFA) then partial illumination shall be used. The EUT can be repositioned so that the front surface remains within the UFA in order to illuminate those sections of the EUT that were previously outside the UFA.

In order to judge the EUT performance, a CCD camera is used to monitor EUT screen.

All the scanning conditions are as follows:

	Condition of Test	Remarks
1	Field Strength	3V/m
2	Radiated Signal	AM 80% Modulated with 1kHz
3	Scanning Frequency	80M - 1000MHz
4	Spot Frequency for Wireless communication device	1800MHz, 2600MHz, 3500MHz, 5000MHz
5	Dwell Time	3.0 seconds or not exceed 5 seconds
6	Frequency Step Size $\Delta f$	1%

### 5.4.4 Deviation from Test Standard

No deviation

### 5.4.5 Test Setup

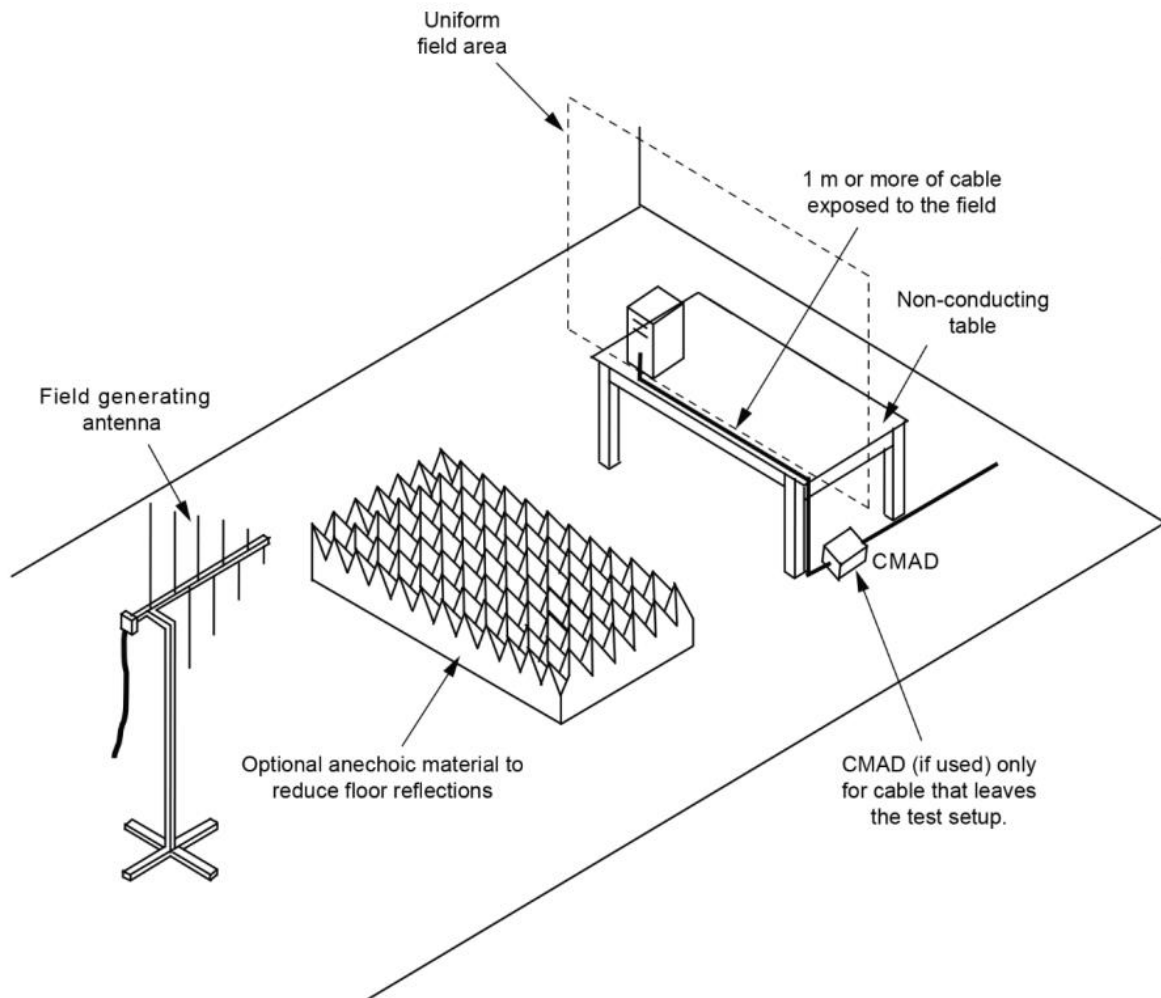



### 5.4.6 Test Result

<b>Test Voltage</b>	230Vac, 50Hz	<b>Environmental Conditions</b>	22°C, 55% RH
<b>Tested by</b>	Andy Li	<b>Test Date</b>	2024/03/01

Frequency Range (MHz)	Azimuth	Polarity	Field Strength (V/m)	Modulation	Result
80-1000	0, 90, 180, 270	H/V	3	80% AM (1kHz)	A
1800	0, 90, 180, 270	H/V	3	80% AM (1kHz)	A
2600	0, 90, 180, 270	H/V	3	80% AM (1kHz)	A
3500	0, 90, 180, 270	H/V	3	80% AM (1kHz)	A
5000	0, 90, 180, 270	H/V	3	80% AM (1kHz)	A

**Note:**

Criteria A: The EUT function was correct during the test.

Not supporting telephony audio output function acoustic/electrical measurements

Frequency Range (MHz)	Azimuth	Polarity	Field Strength (V/m)	Modulation	Result
80-1000	0, 90, 180, 270	H/V	3	80% AM (1kHz)	A
1800	0, 90, 180, 270	H/V	3	80% AM (1kHz)	A
2600	0, 90, 180, 270	H/V	3	80% AM (1kHz)	A
3500	0, 90, 180, 270	H/V	3	80% AM (1kHz)	A
5000	0, 90, 180, 270	H/V	3	80% AM (1kHz)	A

**Note:**

Criteria A: The audio output performance evaluation criteria were satisfied. The interference ratio is -20 dB or better.

### 5.4.7 Photographs of Test Configuration



## 5.5 Electrical Fast Transient /Burst Immunity Test (EFT)

### 5.5.1 Test Specification

<b>Standard</b>	IEC/EN 61000-4-4
<b>Test Voltage</b>	AC Main Power Port: $\pm 1$ kV, DC Network Power Port <sup>(Note 1)</sup> (cable length > 3m): $\pm 0.5$ kV, Analogue/Digital Data Ports (cable length > 3m): $\pm 0.5$ kV,
<b>Polarity</b>	Positive & Negative
<b>Impulse Frequency</b>	CPE xDSL Ports: 100kHz Other: 5kHz
<b>Impulse Wave</b>	5/50 ns
<b>Burst Duration</b>	15 ms
<b>Burst Period</b>	300 ms
<b>Test Duration</b>	Not less than 1 min.

**Note:** 1. Applicable only to port which, according to the manufacturer's specification, support cabled lengths greater than 3m.

### 5.5.2 Test Instrument

Item	Equipment	Manufacturer	Model	Meter No.	Calibration Date
1	EFT Generator	3ctest	EFT500S	CT-1-165	Sep. 20, 2023
2	Clamp	3ctest	CCC100	CT-1-166	Sep. 20, 2023

**Note:** 1. The calibration interval of the above test instruments is 12 months.



### **5.5.3 Test Procedure**

The table-top EUT was placed on a table that is 0.8 meter height. A ground reference plane is placed on the table, and uses 0.1m insulation between the EUT and ground reference plane. The floor-standing EUT was placed on 0.1m insulation support unit between the EUT and ground reference plane.

The minimum area of the ground reference plane is 1m × 1m, and 0.65mm thick min, and projected beyond the EUT by at least 0.1m on all sides.

For input AC power ports:

The EUT is connected to the power mains through a coupling device that directly couples the EFT/B interference signal. Each of the line conductors is impressed with burst noise for 1 minute. The length of the power lines between the coupling device and the EUT is 0.5m.

### **5.5.4 Deviation from Test Standard**

No deviation

### 5.5.5 Test Setup

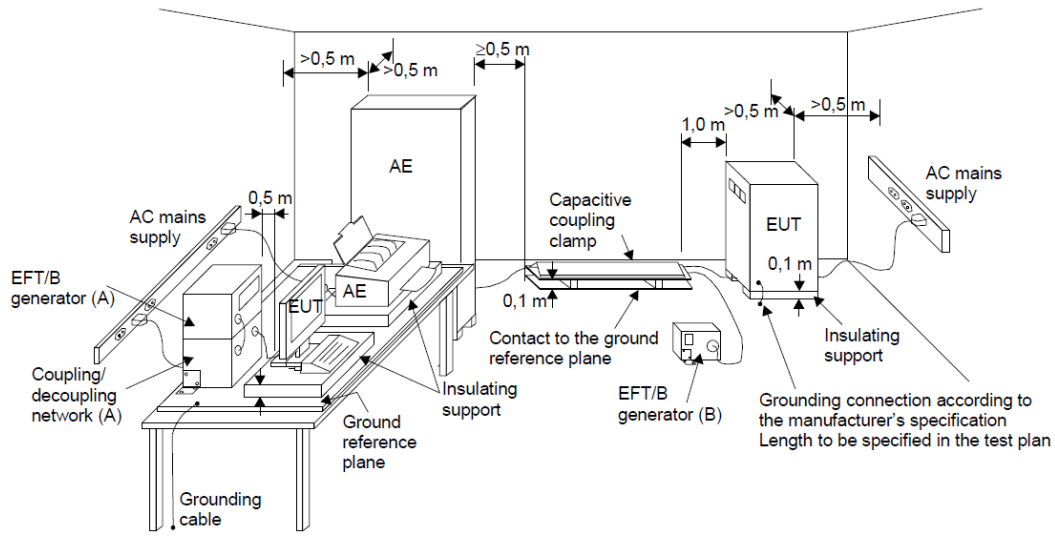

- (A) location for supply line coupling
- (B) location for signal lines coupling

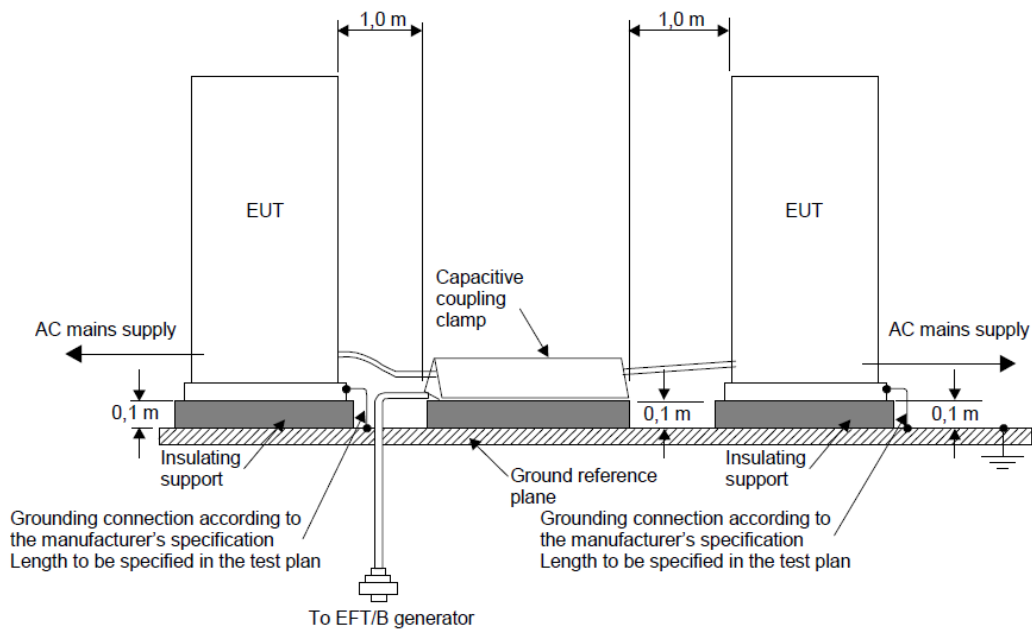



### 5.5.6 Test Result

<b>Test Voltage</b>	230Vac, 50Hz	<b>Environmental Conditions</b>	22°C, 49% RH
<b>Tested by</b>	Guanwei Liao	<b>Test Date</b>	2024/02/29

Test Point		Test Level (kV)	Polarity (+/-)	Result
AC Power Port	L	1	+/-	A
	N	1	+/-	A
	PE	1	+/-	A
	L + N	1	+/-	A
	L + PE	1	+/-	A
	N + PE	1	+/-	A
	L + N + PE	1	+/-	A
Signal Ports Telecommunication Ports	RJ45	0.5	+/-	A

**Note:**

Criteria A: The EUT function was correct during the test.

### 5.5.7 Photographs of Test Configuration

Power



Signal



## 5.6 Surge Immunity Test

### 5.6.1 Test Specification

<b>Standard</b>	IEC/EN 61000-4-5
<b>Wave- Shape</b>	<p>AC Main Power Port: 1.2/50 <math>\mu</math>s Open Circuit Voltage, 8/20 <math>\mu</math>s Short Circuit Current</p> <p>DC Network Power Port <sup>(Note 1)</sup>: 1.2/50 <math>\mu</math>s Open Circuit Voltage, 8/20 <math>\mu</math>s Short Circuit Current</p> <p>Analogue/Digital Data Ports (unshielded symmetrical) (Direct to outdoor cables<sup>(Note 2, 3)</sup>): 10/700 <math>\mu</math>s Open Circuit Voltage, 5/320 <math>\mu</math>s Short Circuit Current</p> <p>Analogue/Digital Data Ports (coaxial or shielded) (Direct to outdoor cables<sup>(Note 2, 3)</sup>): 1.2/50 <math>\mu</math>s Open Circuit Voltage, 8/20 <math>\mu</math>s Short Circuit Current</p>
<b>Test Voltage</b>	<p>AC Main Power Port: line to line <math>\pm 1</math> kV, line to ground <math>\pm 2</math> kV, DC Network Power Port (cable length &gt; 3m): line to ground <math>\pm 0.5</math> kV, Analogue/Digital Data Ports (unshielded symmetrical):line to ground Primary Protection: Intended <math>\pm 1</math> kV and <math>\pm 4</math> kV, Primary Protection: Not Intended <math>\pm 1</math> kV, Analogue/Digital Data Ports (coaxial or shielded): shielded to ground <math>\pm 0.5</math> kV</p>
<b>Surge Input / Output</b>	L1-L2, L1-PE, L2-PE
<b>Polarity</b>	Positive/Negative
<b>Phase Angle</b>	0°/90°/180°/270°
<b>Pulse Repetition Rate</b>	1 time / min. (maximum)
<b>Times</b>	5 Positive and 5 Negative at selected points

- Note:**
1. Applicable only to port which, according to the manufacturer's specification, support cabled lengths greater than 3 m.
  2. Surges are applied with primary protection fitted. Where possible, use the actual primary protector intended to be used in the installation. Where the surge coupling network for the 10/700 (5/320)  $\mu$ s wave affects the functioning of high speed data ports, the test shall be carried out using 1.2/50 (8/20)  $\mu$ s wave and appropriate coupling network.
  3. Surges are applicable to ports which satisfy all the following conditions:  
May connect directly to cables that leave the building structure.  
Defined as an antenna port, a wired network, or a broadcast receiver tuner port.  
Typical port covered include xDSL, PSTN, CATV, antenna and similar. Exclude ports are LAN and similar.

### 5.6.2 Test Instrument

Item	Equipment	Manufacturer	Model	Meter No.	Calibration Date
1	Surge Generator	HAEFELY	AXOS8	CT-1-059(1)	Aug. 07, 2023
2	Surge CDN	3cTest	CDN-405T8A1	CT-1-074(5)	May 26, 2023

**Note:** 1. The calibration interval of the above test instruments is 12 months.

### 5.6.3 Test Procedure

The EUT is placed on a table that is 0.8 meter above a metal ground plane measured 1m × 1m minimum and 0.65mm thick minimum and projected beyond the EUT by at least 0.1m on all sides. The length of power cord between the coupling device and the EUT shall be 2m or less.

For input AC power ports:

The EUT is connected to the power mains through a coupling device that directly couples the surge interference signal.

The surge noise shall be applied synchronized to the voltage phase at 0°, 90°, 180°, 270° and the peak value of the AC voltage wave. (Positive and negative)

Each of Line to Earth and Line to Line is impressed with a sequence of five surge voltages with interval of 1 minute.

## 5.6.4 Deviation from Test Standard

No deviation

## 5.6.5 Test Setup

< Table-Top equipment >

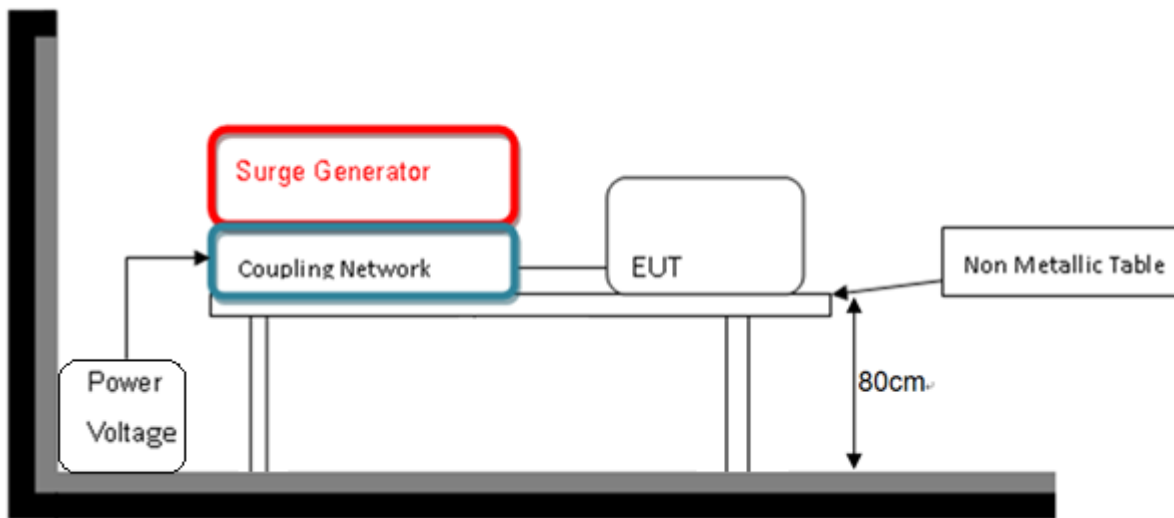

< Floor-Standing equipment >

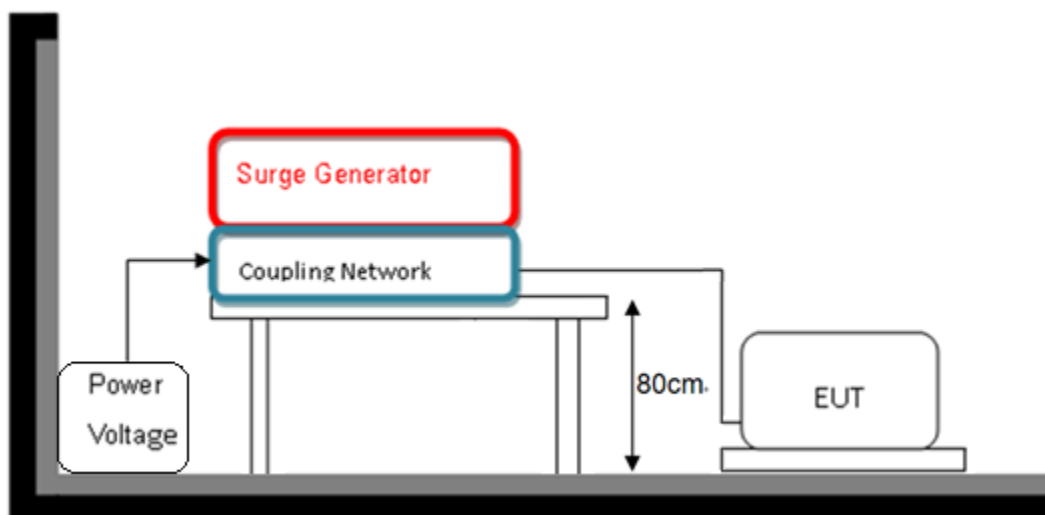



### 5.6.6 Test Result

<b>Test Voltage</b>	230Vac, 50Hz	<b>Environmental Conditions</b>	24°C, 55% RH
<b>Tested by</b>	Eric Hsieh	<b>Test Date</b>	2024/03/01

AC Power Port						
Test Point	Phase	Polarity (+/-)	Test Voltage (kV)			Result
			0.5	1	2	
L to N	0°	+/-	A	A	-	A
	90°	+/-	A	A	-	
	180°	+/-	A	A	-	
	270°	+/-	A	A	-	
L to PE	0°	+/-	A	A	A	A
	90°	+/-	A	A	A	
	180°	+/-	A	A	A	
	270°	+/-	A	A	A	
N to PE	0°	+/-	A	A	A	A
	90°	+/-	A	A	A	
	180°	+/-	A	A	A	
	270°	+/-	A	A	A	

**Note:**

Criteria A: The EUT function was correct during the test.



### 5.6.7 Photographs of Test Configuration

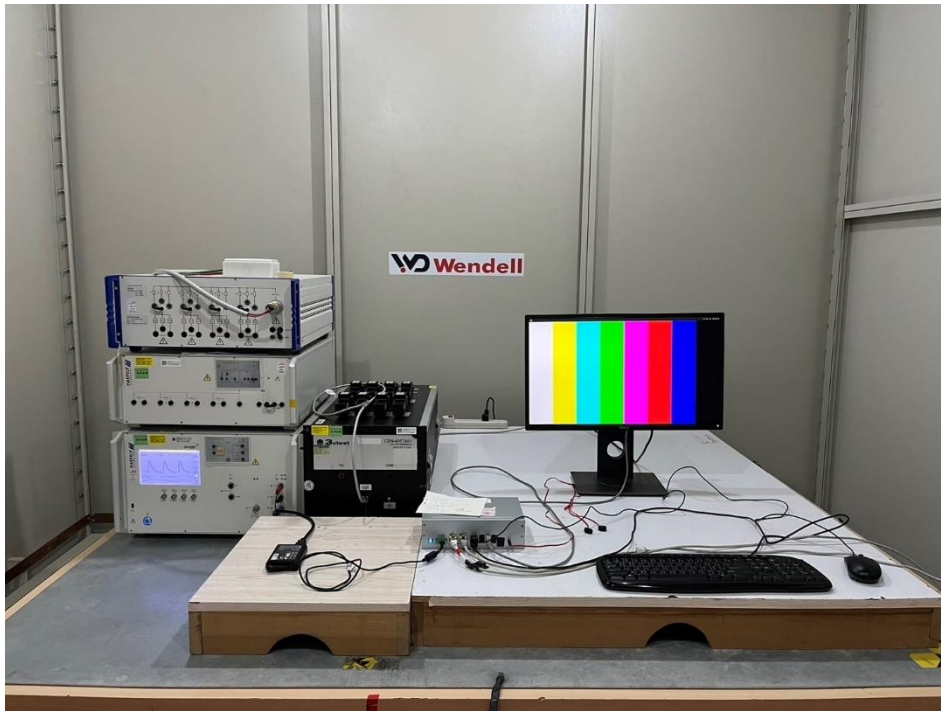

## 5.7 Continuous Conducted Disturbances (CS)

### 5.7.1 Test Specification

<b>Standard</b>	IEC/EN 61000-4-6
<b>Frequency Range</b>	0.15 ~ 10 MHz, 10 ~ 30 MHz, 30 ~ 80 MHz,
<b>Voltage Level</b>	3 V(rms), 3 - 1 V(rms), 1 V(rms)
<b>Modulation</b>	AM Modulation, 80%, 1 kHz Sine Wave
<b>Frequency Step</b>	1% of fundamental
<b>Dwell Time</b>	3 seconds

### 5.7.2 Test Instrument

Item	Equipment	Manufacturer	Model	Meter No.	Calibration Date
1	Coupling clamp according to IEC 6100-4-6	FRANKONIA	EMCL-20	CT-1-049	Jun. 09, 2023
2	CDN for power supply lines	FRANKONIA	CDN M2+M3	CT-1-054	Jun. 09, 2023
3	6 dB Attenuator	BIRD	75-A-FFN-06	CT-1-056	Jun. 09, 2023
4	Compact Immunity Test System acc	FRANKONIA	CIT-10/75	CT-1-057	May 31, 2023
5	CDN for screened lines	FRANKONIA	RJ45S	CT-1-052(1)	Jun. 09, 2023
6	50ohm Termination	N/A	N/A	CT-1-065-1	Jun. 12, 2023
7	Measurement Software	HUBERT	Ver: 1.1.2	N/A	No calibration request
8	Conditioning Amplifier / Microphone	B & K	2690-OS2 / 4192-L-001	CT-1-157	May 25, 2023
9	Sound Level Calibrator	B & K	4231	CT-1-156	Jun. 01, 2023
10	Sound Analyer	VGT	ABT CB0	CT-1-159	May 31, 2023
11	Frequency Counter	HEWLETT PACKARD	53181A	CT-1-158	May 28, 2023
12	Audio output Measurement Software	VGT	V1.2-WD	N/A	No calibration request

**Note:** 1. The calibration interval of the above test instruments is 12 months.

### **5.7.3 Test Procedure**

The EUT is placed on 0.1m insulation support unit between the EUT and ground reference plane.

**For input AC power ports:**

The EUT is connected to the power mains through a coupling and decoupling networks for power supply lines. And directly couples the disturbances signal into EUT.

Auxiliary equipment (AE) required for the defined operation of the EUT according to the specifications of the product committee.

## 5.7.4 Deviation from Test Standard

No deviation

## 5.7.5 Test Setup

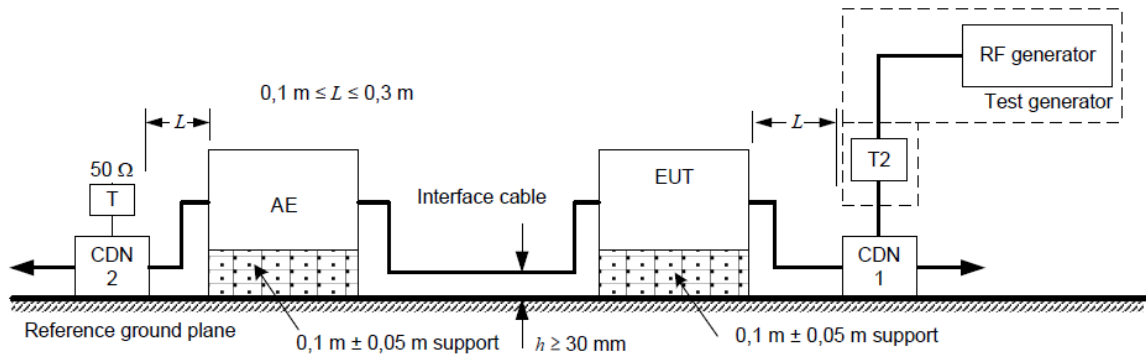

The interface cable is set at 1 m if possible.

a) Schematic setup for a 2-port EUT connected to only 1 CDN

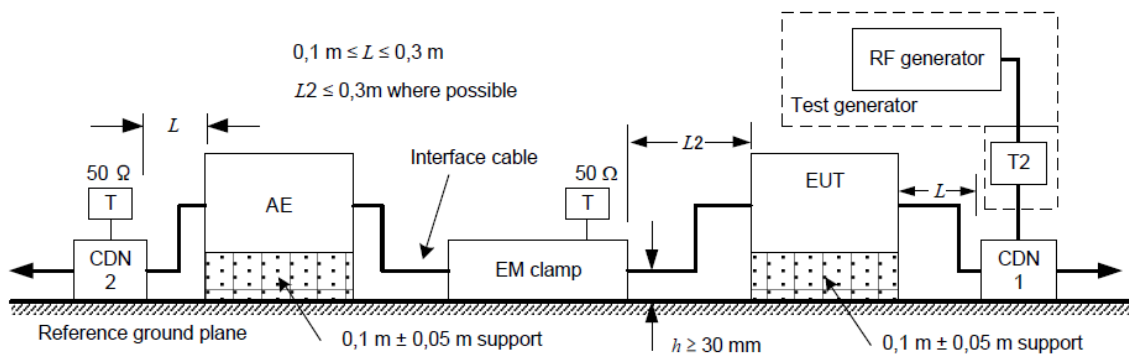

### Note:

T: Termination 50 Ω

T2: Power attenuator (6 dB)

CDN: Coupling and decoupling network

Injection clamp: current clamp or EM clamp



### 5.7.6 Test Result

<b>Test Voltage</b>	230Vac, 50Hz	<b>Environmental Conditions</b>	21°C, 49% RH
<b>Tested by</b>	Alan Chung	<b>Test Date</b>	2024/02/29

Frequency Range (MHz)	Tested Port	Injection Method	Test Level (V <sub>r.m.s.</sub> )	Modulation	Result
0.15 - 10	AC Power	CDN-M2 +M3 (M3)	3	80% AM, 1kHz	A
10 - 30	AC Power	CDN-M2 +M3 (M3)	3 - 1	80% AM, 1kHz	A
30 - 80	AC Power	CDN-M2 +M3 (M3)	1	80% AM, 1kHz	A
0.15 - 10	RJ45	CLAMP	3	80% AM, 1kHz	A
10 - 30	RJ45	CLAMP	3 - 1	80% AM, 1kHz	A
30 - 80	RJ45	CLAMP	1	80% AM, 1kHz	A

**Note:**

Criteria A: The EUT function was correct during the test.

Not supporting telephony audio output function acoustic/electrical measurements

Frequency Range (MHz)	Tested Port	Injection Method	Test Level (V <sub>r.m.s.</sub> )	Modulation	Result
0.15 - 10	AC Power	CDN-M2 +M3 (M3)	3	80% AM, 1kHz	A
10 - 30	AC Power	CDN-M2 +M3 (M3)	3 - 1	80% AM, 1kHz	A
30 - 80	AC Power	CDN-M2 +M3 (M3)	1	80% AM, 1kHz	A

**Note:**

Criteria A: The audio output performance evaluation criteria were satisfied. The interference ratio is -20 dB or better.

### 5.7.7 Photographs of Test Configuration

Power



Signal

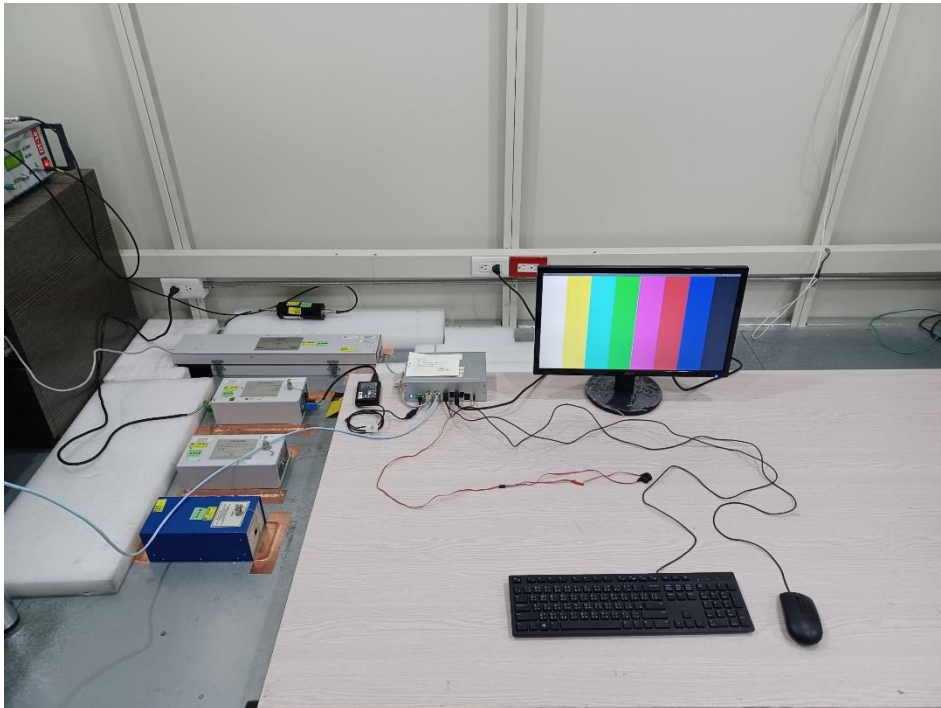

## 5.8 Power Frequency Magnetic Field Immunity Test

### 5.8.1 Test Specification

<b>Standard</b>	IEC/EN 61000-4-8
<b>Frequency Range</b>	50/60Hz
<b>Field Strength</b>	1 A/m
<b>Observation Time</b>	1 minute
<b>Inductance Coil</b>	Rectangular type, 1mx1m

**Note:** 1. Applicable only to equipment containing devices intrinsically susceptible to magnetic field, such as CRT monitors, Hall effect elements, electron-dynamic microphones, magnetic field sensors or audio frequency transformers.

### 5.8.2 Test Instrument

<b>Item</b>	<b>Equipment</b>	<b>Manufacturer</b>	<b>Model</b>	<b>Meter No.</b>	<b>Calibration Date</b>
1	PFMF	SGH	HMFG1000	CT-1-164	Sep. 28, 2023

**Note:** 1. The calibration interval of the above test instruments is 24 months.

### 5.8.3 Test Procedure

The table-top EUT was placed on a table which is 0.8 meter above a metal ground plane measured at least 1m x 1m minimum. The test magnetic field shall be placed at central of the induction coil. The floor-standing EUT was placed on 0.1m insulation support unit between the EUT and ground reference plane.

The test magnetic Field shall be applied 10 minutes by the immersion method to the table-top EUT, and the induction coil shall be rotated by 90° in order to expose the EUT to the test field with different orientation (X, Y, Z Orientations). The test magnetic Field shall be applied 10 minutes by the proximity method to the floor-standing EUT, and the induction coil shall be rotated by 90° in order to expose the EUT to the test field with different orientation (X, Y, Z Orientations).

### 5.8.4 Deviation from Test Standard

No deviation

### 5.8.5 Test Setup

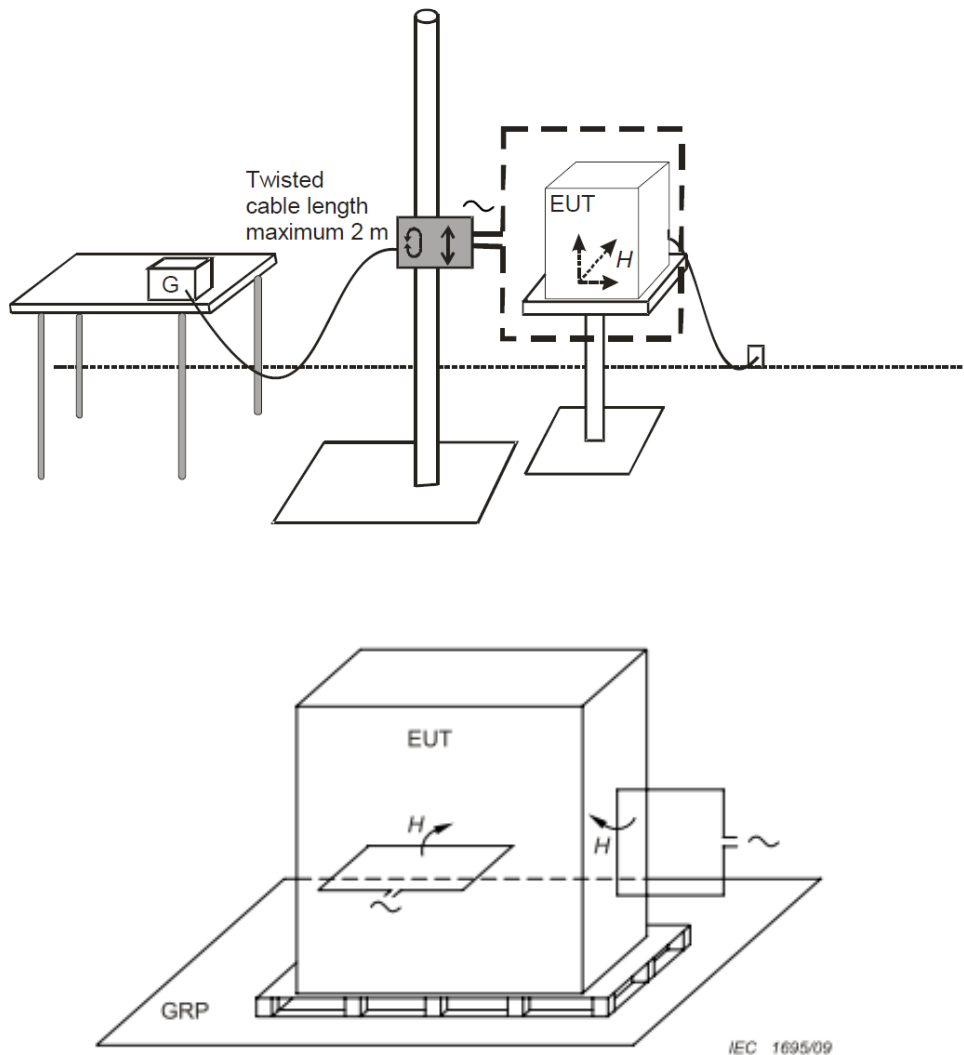

For the actual test configuration, please refer to 5.8.7.

**NOTE:**

**TABLETOP EQUIPMENT**

The equipment shall be subjected to the test magnetic field by using the induction coil of standard dimension (1 m x 1 m). The induction coil shall then be rotated by 90 degrees in order to expose the EUT to the test field with different orientations.

**FLOOR-STANDING EQUIPMENT**

The equipment shall be subjected to the test magnetic field by using induction coils of suitable dimensions. The test shall be repeated by moving and shifting the induction coils, in order to test the whole volume of the EUT for each orthogonal direction. The test shall be repeated with the coil shifted to different positions along the side of the EUT, in steps corresponding to 50 % of the shortest side of the coil. The induction coil shall then be rotated by 90 degrees in order to expose the EUT to the test field with different orientations.





### 5.8.6 Test Result

<b>Test Voltage</b>	230Vac, 50Hz	<b>Environmental Conditions</b>	21°C, 49% RH
<b>Tested by</b>	Alan Chung	<b>Test Date</b>	2024/02/29

<b>Test Coil Position</b>	<b>Frequency (Hz)</b>	<b>Magnetic Strength (A/m)</b>	<b>Result</b>
X - Axis	50/60	1	A
Y - Axis	50/60	1	A
Z - Axis	50/60	1	A

**Note:**

Criteria A: The EUT function was correct during the test.

### 5.8.7 Photographs of Test Configuration



## 5.9 Voltage Dips & Short Interruptions

### 5.9.1 Test Specification

<b>Basic Standard</b>	IEC/EN 61000-4-11
<b>Test Level</b>	Voltage Dips: >95% reduction - 0.5 period 30% reduction - 25 period Voltage Interruptions: >95% reduction - 250 period
<b>Test Duration Time</b>	Minimum 3 test events in sequence
<b>Interval between Event</b>	Minimum 10 seconds
<b>Phase Angle</b>	0° / 180°
<b>Test Cycle</b>	3 times

**Note:** 1. Changes to occur at 0 degree crossover point of the voltage waveform. If the EUT does not demonstrate compliance when tested with 0 degree switching, the test shall be repeated with the switching occurring at both 90 degrees and 270 degrees. If the EUT satisfies these alternative requirements, then it fulfils the requirements. This condition shall be recorded in the test report.

### 5.9.2 Test Instrument

Item	Equipment	Manufacturer	Model	Meter No.	Calibration Date
1	DIP Simulator	3ctest	PFS2216S	CT-1-167	Sep. 20, 2023

**Note:** 1. The calibration interval of the above test instruments is 12 months.

### **5.9.3 Test Procedure**

Before starting the test of a given EUT, a test plan shall be prepared.

The test plan should be representative of the way the system is actually used.

Systems may require a precise pre-analysis to define which system configurations must be tested to reproduce field situations.

Test cases must be explained and indicated in the Test report.

It is recommended that the test plan include the following items:

- the type designation of the EUT;
- information on possible connections (plugs, terminals, etc.) and corresponding cables, and peripherals;
- input power port of equipment to be tested;
- representative operational modes of the EUT for the test;
- performance criteria used and defined in the technical specifications;
- operational mode(s) of equipment;
- description of the test set-up.

If the actual operating signal sources are not available to the EUT, they may be simulated.

For each test, any degradation of performance shall be recorded. The monitoring equipment should be capable of displaying the status of the operational mode of the EUT during and after the tests. After each group of tests, a full functional check shall be performed.

### **5.9.4 Deviation from Test Standard**

No deviation

### 5.9.5 Test Setup

< Table-Top equipment >

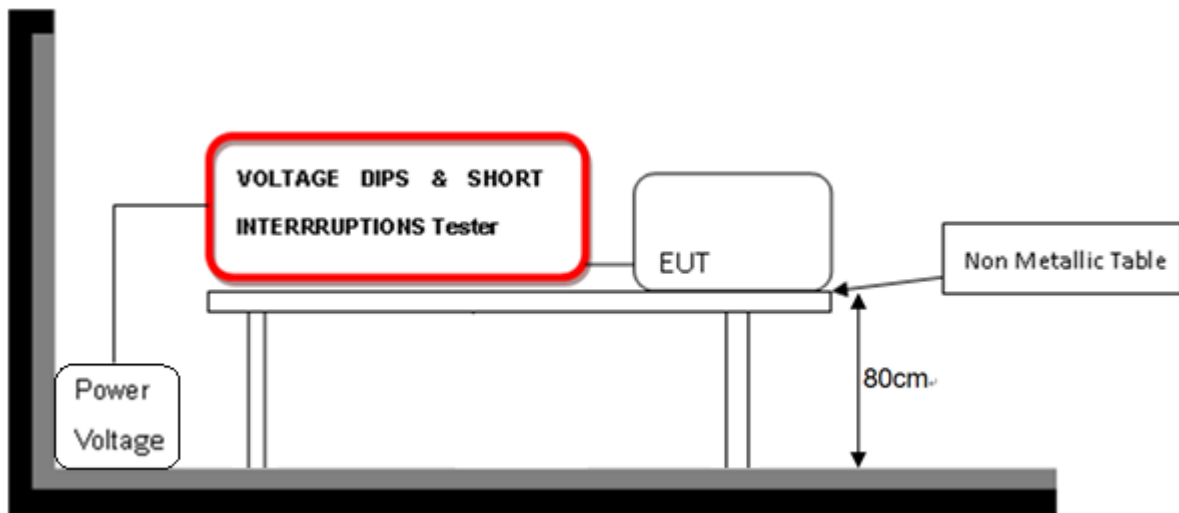

< Floor-Standing equipment >

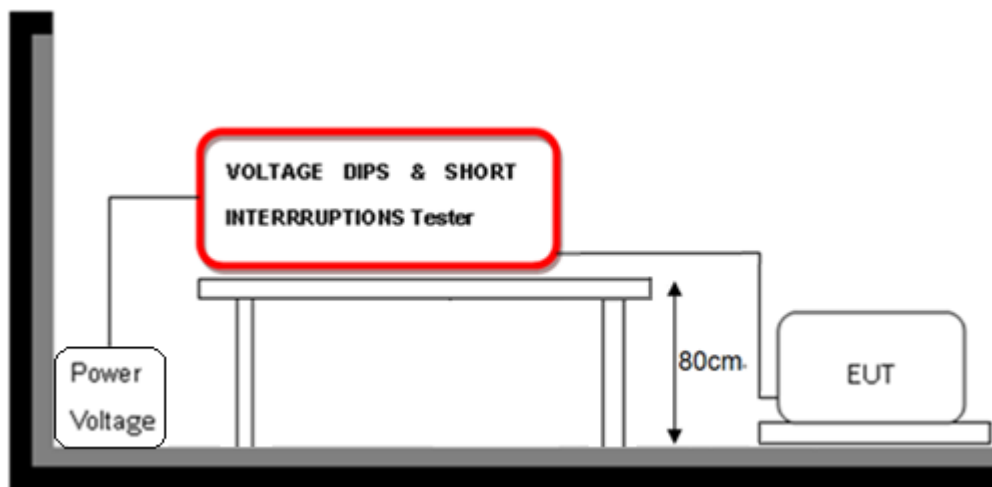



### 5.9.6 Test Result

<b>Test Voltage</b>	100-240Vac, 50Hz	<b>Environmental Conditions</b>	21°C, 49% RH
<b>Tested by</b>	Guanwei Liao	<b>Test Date</b>	2024/02/29

230Vac, 50Hz			
Test Item	% Reduction	Duration (Period)	Result
Voltage Dips	>95	0.5	A
	30	25	A
Voltage interruptions	>95	250	C (#1)

240Vac, 50Hz			
Test Item	% Reduction	Duration (Period)	Result
Voltage Dips	>95	0.5	A
	30	25	A
Voltage interruptions	>95	250	C (#1)

100Vac, 50Hz			
Test Item	% Reduction	Duration (Period)	Result
Voltage Dips	>95	0.5	A
	30	25	C (#1)
Voltage interruptions	>95	250	C (#1)

**Note:**

Criteria A: The EUT function was correct during the test.

Criteria C: (#1) The EUT was shut down during the test, and must be recovered manually.

### 5.9.7 Photographs of Test Configuration



< End Page >